

Go to
www.vtechphones.com to
register your product for
enhanced warranty support
and the latest VTech product
news.

CM18045

4-Line
Small Business System
Cordless Handset



vtech[®]
User's manual

Congratulations

on your purchase of this VTech product. Before using this product, please read the **Important safety information**.

This user's manual provides you with the complete installation and setup instructions.

For customer service or product information, visit our website at **www.vtechphones.com** or call **1 (800) 595-9511**. In Canada, please dial **1 (800) 267-7377**.

Model number: CM18045

Type: 4-Line Small Business System Cordless Handset

Serial number: _____

Purchase date: _____

Place of purchase: _____

Both the model and serial numbers of your VTech product can be found on the bottom of the charger.

Save your sales receipt and original packaging in case it is necessary to return your telephone for warranty service.



Telephones identified with this logo have reduced noise and interference when used with most T-coil equipped hearing aids and cochlear implants. The TIA-1083 Compliant Logo is a trademark of the Telecommunications Industry Association. Used under license.



The ENERGY STAR® program (www.energystar.gov) recognizes and encourages the use of products that save energy and help protect our environment. We are proud to mark this product with the ENERGY STAR® label indicating it meets the latest energy efficiency guidelines.

Important safety information



This symbol is to alert you to important operating or servicing instructions that may appear in this user's manual. Always follow basic safety precautions when using this product to reduce the risk of injury, fire, or electric shock.

Safety information

- Read and understand all instructions in the user's manual. Observe all markings on the product.
- Avoid using a telephone during a thunderstorm. There may be a slight chance of electric shock from lightning.
- Do not use the telephone to report a gas leak in the vicinity of the leak. Under certain circumstances, a spark may be created when the adapter is plugged into the power outlet, or when the handset is replaced in its cradle. This is a common event associated with the closing of any electrical circuit. The user should not plug the phone into a power outlet, and should not put a charged handset into the cradle, if the phone is located in an environment containing concentrations of flammable or flame-supporting gases, unless there is adequate ventilation. A spark in such an environment could create a fire or explosion. Such environments might include: medical use of oxygen without adequate ventilation; industrial gases (cleaning solvents; gasoline vapors; etc.); a leak of natural gas; etc.
- Do not use this product near water, or when you are wet. For example, do not use it in a wet basement or shower, or next to a swimming pool, bathtub, kitchen sink, or laundry tub. Do not use liquids or aerosol sprays for cleaning. If the product comes in contact with any liquid, unplug any line or power cord immediately. Do not plug the product back in until it has dried thoroughly.
- Avoid placing the telephone system in places with extreme temperature, direct sunlight, or other electrical devices. Protect your phone from moisture, dust, corrosive liquids and fumes.
- Install this product in a protected location where no one can trip over any line or power cords. Protect cords from damage or abrasion.
- If this product does not operate normally, see the **Troubleshooting** section on pages 78-86. If you cannot solve the problem, or if the product is damaged, refer to the **Limited warranty** section on pages 96-98. Do not open this product except as directed in the user's manual. Opening the product or reassembling it incorrectly may expose you to hazardous voltages or other risks.
- Replace backup battery only as described in the user's manual. Do not burn or puncture batteries — they contain caustic chemicals.
- This power adapter is intended to be correctly oriented in a vertical or floor mount position. The prongs are not designed to hold the plug in place if it is plugged into a ceiling, an under-the-table or cabinet outlet.

Important safety information

- For PLUGGABLE EQUIPMENT, the socket-outlet shall be installed near the equipment and shall be easily accessible.



Caution:

- Use only the power adapter provided with this product. To obtain a replacement, visit our website at www.vtechphones.com, or call **1 (800) 595-9511**. In Canada, dial **1 (800) 267-7377**.
- Use only the supplied rechargeable battery or replacement battery (model BT283342). To order a replacement battery, visit our website at www.vtechphones.com, or call **1 (800) 595-9511**. In Canada, dial **1 (800) 267-7377**.
- To prevent risk of fire or battery explosion, replace with the correct battery type. Dispose of used batteries according to the instructions.

Especially about cordless telephones

- Privacy: The same features that make a cordless telephone convenient create some limitations. Telephone calls are transmitted between the console and the handset by radio waves, so there is a possibility that your cordless telephone conversations could be intercepted by radio receiving equipment within range of the cordless handset. For this reason, you should not think of cordless telephone conversations as being as private as those on corded telephones.
- Electrical power: The console of this cordless telephone must be connected to a working electrical outlet which is not controlled by a wall switch. Calls cannot be made from the handset if the console is unplugged, switched off or if the electrical power is interrupted.
- Potential TV interference: Some cordless telephones operate at frequencies that may cause interference to TVs and VCRs. To minimize or prevent such interference, do not place the console of the cordless telephone near or on top of a TV or VCR. If interference is experienced, moving the cordless telephone farther away from the TV or VCR will often reduce or eliminate the interference.
- Rechargeable batteries: This product contains nickel-metal hydride rechargeable batteries. Exercise care in handling batteries in order not to create a short circuit with conductive material such as rings, bracelets, and keys. The battery or conductor may overheat and cause harm. Observe proper polarity between the battery and the battery charger.
- Nickel-metal hydride rechargeable batteries: Dispose of these batteries in a safe manner. Do not burn or puncture. Like other batteries of this type, if burned or punctured, they could release caustic material which could cause injury.



The RBRC® Seal means that the manufacturer is voluntarily participating in an industry program to collect and recycle nickel-metal hydride rechargeable batteries when taken out of service within the United States. These batteries may be taken to a participating local retailer of replacement batteries or recycling center. You may call 1 (800) 8-BATTERY® for locations accepting spent Ni-MH batteries.

RBRC® and 1-800-8-BATTERY® are registered trademarks of the Rechargeable Battery Recycling Corporation.

Important safety information

Precautions for users of implanted cardiac pacemakers

Cardiac pacemakers (applies only to digital cordless telephones):

Wireless Technology Research, LLC (WTR), an independent research entity, led a multidisciplinary evaluation of the interference between portable wireless telephones and implanted cardiac pacemakers. Supported by the U.S. Food and Drug Administration, WTR recommends to physicians that:

Pacemaker patients

- Should keep wireless telephones at least six inches from the pacemaker.
- Should NOT place wireless telephones directly over the pacemaker, such as in a breast pocket, when it is turned ON.
- Should use the wireless telephone at the ear opposite the pacemaker.

WTR's evaluation did not identify any risk to bystanders with pacemakers from other persons using wireless telephones.

Especially about telephone answering systems

Two-way recording: This unit does not sound warning beeps to inform the other party that the call is being recorded. To ensure that you are in compliance with any federal or state regulations regarding recording a telephone call, you should start the recording process and then inform the other party that you are recording the conversation.

SAVE THESE INSTRUCTIONS

Parts checklist

Your telephone package contains the following items. Save your sales receipt and original packaging in the event warranty service is necessary.



User's manual



Quick start guide



Cordless handset



Battery compartment cover



Battery for cordless handset



Charger for cordless handset with power adapter installed



Belt clip

Table of contents

Getting started

Installation	1
Charger installation.....	3
Battery installation and charging	4
Wall mount installation (Optional)	6
Add and register a handset	8
Use a belt clip (Optional)	9
Add a corded headset (Optional)	10
Handset overview	11
Handset screen icons	17
Alert tones and lights.....	18

Telephone settings

Telephone setup	19
Menu settings	19
Ringer volume	20
Ringer tone	21
Do not disturb (DND).....	21
LCD contrast	22
Key tone	22
Auto key lock	23
LCD Language	23
Primary line	24
Call privacy.....	24
Hold reminder.....	25
Handset name	25
Factory reset	26
Handset information	26
User support.....	26

Telephone operation

Telephone operation	27
Line indicators	27
Making and ending a call.....	27
On hook dialing (predialing) ...	27
Using the speakerphone	28
Answering a call	28
Temporary ringer silencing	28
Lock keypad	28
Options while on calls.....	29
Call waiting	29
Volume control.....	29
Mute	29
Hold	30
Switching between lines	30
Call privacy.....	31
Recording a call.....	32
Chain dialing.....	33
Redial	34
Conference call.....	36
Establish a conference call.....	36
Options during a conference call.....	38
Intercom.....	40
Make an intercom call to an extension.....	40
Answer an intercom call	40
End an intercom call.....	40
Answer an incoming call during an intercom call.....	41
Hold an intercom call.....	41

Table of contents

Handle an intercom call by the private mailbox	41	Call history	
Call transfer	42	About the caller ID	53
Blind transfer	42	Information about caller ID with call waiting	53
Transfer a call and speak to the receiving party	42	Caller ID information	54
Paging	43	How the caller ID information (call log) works	54
Make a paging call to an extension	43	Caller ID operation	55
Set and edit a group for paging call	44	Memory match	55
Make a paging call to multiple extensions	45	Missed (new) calls indicator ...	55
End a paging call	45	Review the caller ID information	56
Delete the group settings	45	View dialing options	56
Speed dial	46	Dial a call history entry	57
Assign a speed dial entry	46	Save a caller ID entry to the directory	57
Dial a speed dial entry	47	Delete entries	58
Delete a speed dial entry	47	Reasons for missing caller ID information	59
Directory		Answering system	
About the directory	48	Private mailbox setup	60
Capacity	48	Activate private mailbox	60
Exit the directory	48	Number of rings	61
Create directory entries	49	Voice language	61
Create a new directory entry ..	49	Announcement	62
Review directory entries	50	Remote access code	64
Search directory	51	Message Length	64
Search by name	51	Call screening	65
Dial, delete or edit entries	52	Call intercept	65
Display dial	52	Message alert	66
Delete an entry	52	Remaining time	66
Edit an entry	52		

Table of contents

Answering system operation	67
New message indication	67
Call screening.....	67
Call intercept	67
Message playback.....	68
Options during playback.....	69
Transfer messages	69
Delete all mailbox messages..	70
Record memo.....	71
Remote access.....	72

Appendix

Deregister a handset	74
Handset display screen messages.....	75
Troubleshooting	78
Maintenance	87
FCC Part 68 and ACTA	88
FCC Part 15.....	90
California Energy Commission battery charging testing instructions.....	91
For C-UL compliance only	92
Limited warranty	96
Technical specifications	99
Index	100

Getting started

Installation

This CM18045 handset is an accessory of CM18445 concole. You must purchase the CM18445 console and register this handset to the console before use.

Install and set up CM18445 console first before expanding your system with this CM18045 handset.

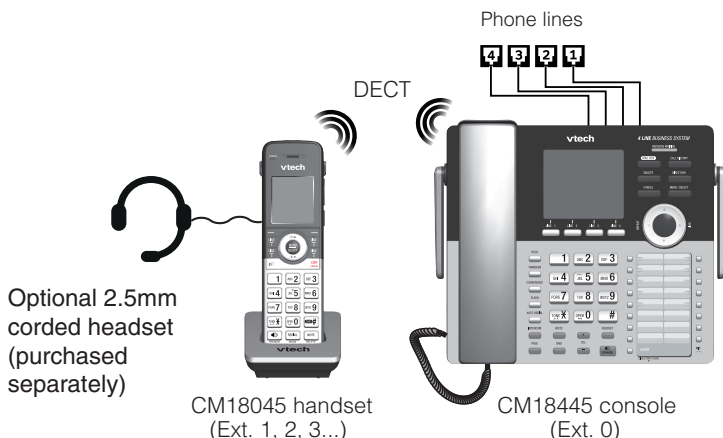

Install the handset close to a power outlet not controlled by a wall switch. The handset can be placed on a flat surface or vertically mounted on the wall (pages 6-7).

Your product may be shipped with a protective sticker covering the handset display, remove it before use.

For customer service or product information, visit our website at www.vtechphones.com or call 1 (800) 595-9511. In Canada, dial 1 (800) 267-7377.

Getting started

Installation

Avoid placing the handset too close to:

- Communication devices such as television sets, VCRs, or other cordless telephones.
- Excessive heat sources.
- Noise sources such as a window with traffic outside, motors, microwave ovens, refrigerators, or fluorescent lighting.
- Excessive dust sources such as a workshop or garage.
- Excessive moisture.
- Extremely low temperature.
- Mechanical vibration or shock such as on top of a washing machine or work bench.

Getting started

Charger installation



The power adapter is intended to be correctly oriented in a vertical or floor mount position. The prongs are not designed to hold the plug in place if it is plugged into a ceiling, under-the-table or cabinet outlet.

Install the charger as shown below.

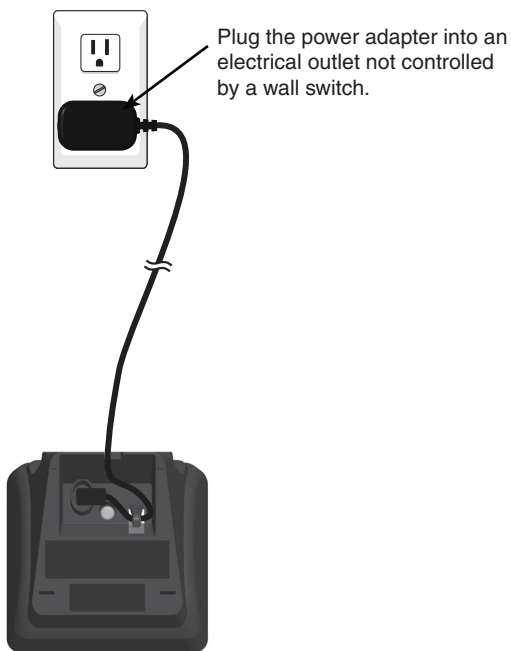



NOTE: Use only the power adapter supplied with this product. To order a replacement power adapter, visit our website at www.vtechphones.com, or call 1 (800) 595-9511. In Canada, dial 1 (800) 267-7377.

Getting started

Battery installation and charging

Install the battery as shown on the next page. Once you have installed the battery, the screen indicates the battery status (see the table below). If necessary, place the handset in the charger to charge the battery. For best performance, keep the handset in the charger when not in use. The battery is fully charged after 16 hours of continuous charging. See the table on page 99 for battery operating times.

If the screen is blank, you need to charge the handset without interruption for at least 30 minutes to give the handset enough charge to use the telephone for a short time. When the battery is low, the handset shows a flashing .

Battery indicators	Battery status	Action
The screen is blank or shows Place in charger and  flashes.	The battery has no or very little charge. The handset cannot be used.	Charge without interruption (at least 30 minutes).
The screen shows  and it flashes.	Battery has enough charge to be used for a short time.	Charge without interruption (at least 30 minutes).
The screen shows Handset X . (X represents the extension number of the handset).	Battery is charged.	To keep the battery charged, place it in the or charger when not in use.

Getting started

Battery installation and charging

Install the battery as shown below.

1. Plug the battery connector securely into the socket inside the handset battery compartment. Insert the supplied battery with the label **THIS SIDE UP** facing up as indicated.
2. Align the cover flat against the battery compartment, then slide it upwards until it clicks into place.
3. Charge the handset by placing it face forward in the charger. The charge light is on when charging.



NOTES:

- Use only the supplied rechargeable battery or replacement battery (model BT283342). To order a replacement battery, visit our website at www.vtechphones.com, or call 1 (800) 595-9511. In Canada, dial 1 (800) 267-7377.
- If you do not use the handset for a long time, disconnect and remove the battery to prevent possible leakage.

Getting started

Wall mount installation (Optional)

The charger is ready for tabletop use. If you want to mount the charger on a wall, use two 10mm screws and wall anchors (not provided) to hold the charger in place. The screws and wall anchors are available for purchase in many hardware or consumer electronics retailers. You might need a professional to install the charger.

To mount the charger on the wall

1. Use a pencil to mark the desired positions of the two holes on the wall, make sure the space between the two holes is 30mm. Drill two holes in the wall according to the marks.

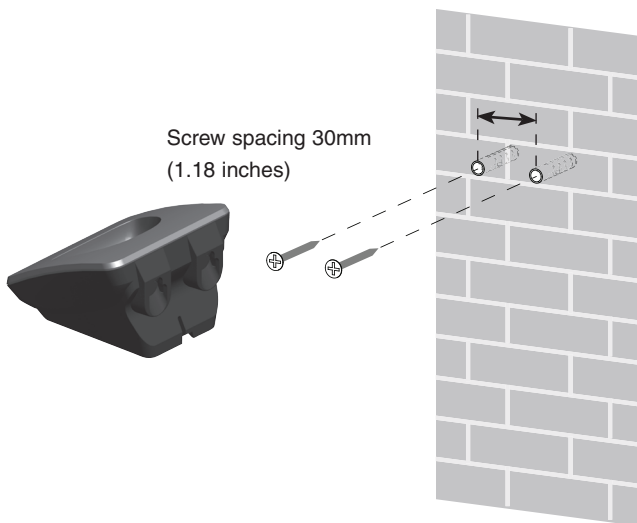

2. If you drill the holes into a stud, go to step 3.

-OR-

If you drill the holes into an object other than a stud, insert the wall anchors (not provided) into the holes and tap gently on the ends with a hammer until the wall anchors are flush with the wall.

Getting started

Wall mount installation (Optional)

3. Insert the screws (not provided) into the holes and tighten them until only 1/4 inch of the screws are exposed.



4. Align the holes at the back of the charger with the screws on the wall and slide the charger down until it locks into place.

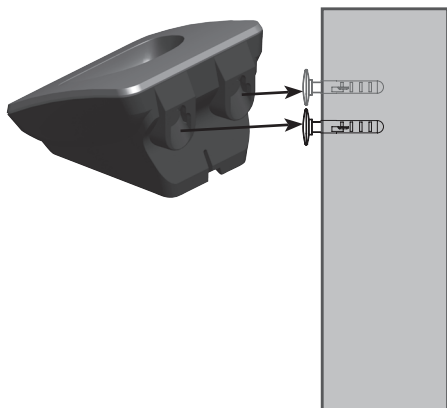

Getting started

Add and register a handset

You can add CM18045 handsets to the CM18445 console at any time, each new handset must be registered with the console before use.

The handsets are assigned with available extension numbers starting from 1 in ascending order (1 to 9). You can register a maximum of nine devices to the console.

To register the handset to the CM18445 console:

Start registration when the handset shows

1) Press MENU on Console ->Registration ->Register Ext. 2) Press # on this extension to register.

1. On the console, press **MENU/SELECT**.
2. Press ▲ or ▼ to scroll to **Registration**, then press **MENU/SELECT** or ►/SKIP.
3. Press **MENU/SELECT** or ►/SKIP to choose **Register ext**. The console shows **Registering....**
4. On the handset, press **#**. The handset shows **Registering....**
5. You hear a beep sound when the registration process is successful. The handset shows **Handset X registered.** (X represents the extension number, ranged from 1 to 9). It takes up to 60 seconds to complete the registration process.
6. Press a line key (**LINE 1 - LINE 4**). If you hear a dial tone, the registration was successful.

```
1) Press MENU
on Console
->Registration
->Register Ext.
2) Press # on
this extension
to register.
```

```

  ▲
Directory
Call log
Ringer setting
Console setup
Line mode
Ans sys setup
>Registration
```

```

  ▲
Registration:
>Register ext
Deregistration
```

```
Handset X
registered.
```



NOTE: If the registration is not successful, the console returns to the previous screen. To reset the handset, remove the handset from the charger. Wait for about two minutes, then try the registration process again.

Getting started

Use a belt clip (Optional)

Install the belt clip, if desired.



Snap the belt clip into notches on both sides of the handset.



To release the belt clip, pull and unlock one flap from its notch first before detaching the whole belt clip from the handset.

Getting started

Add a corded headset (Optional)

You can use this handset handsfree when you install any industry-standard 2.5mm corded telephone headset (purchased separately).

Side view of the handset

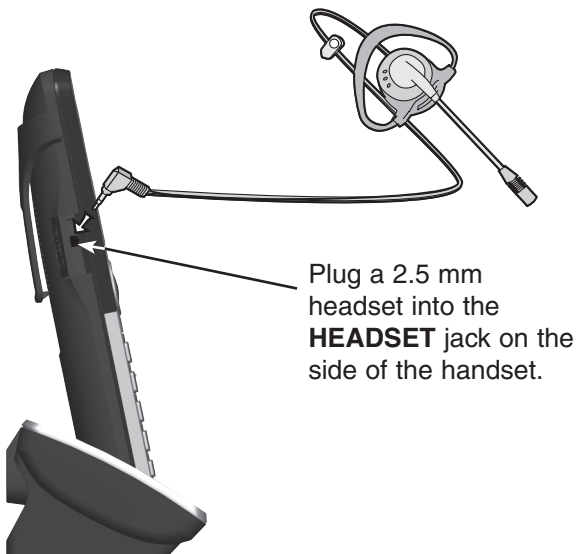

Getting started

Handset overview

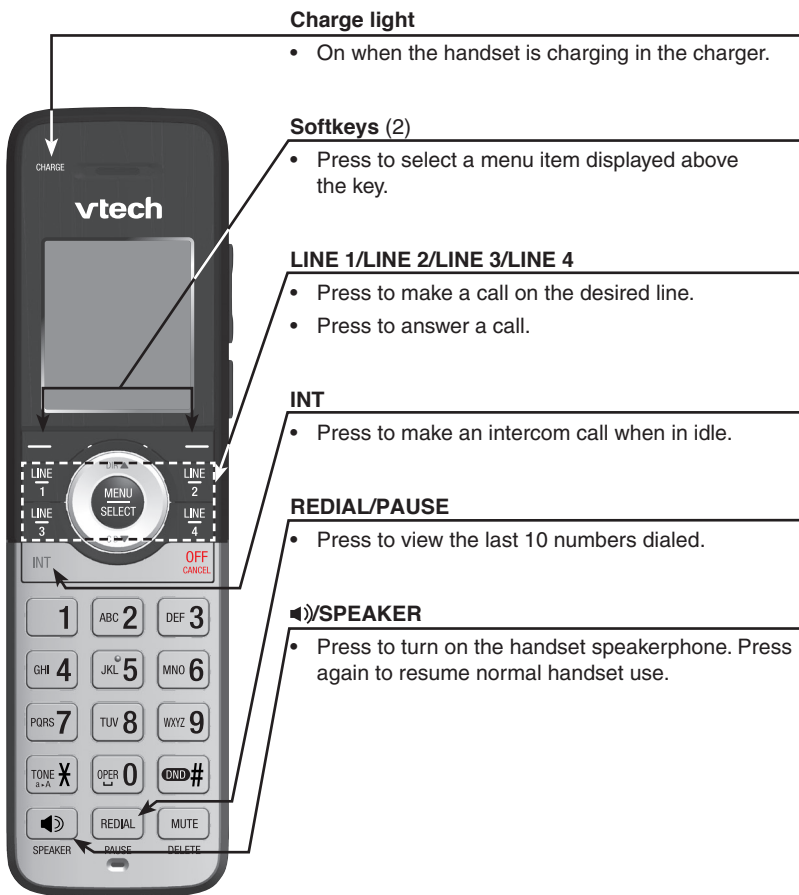

Getting started

Handset overview

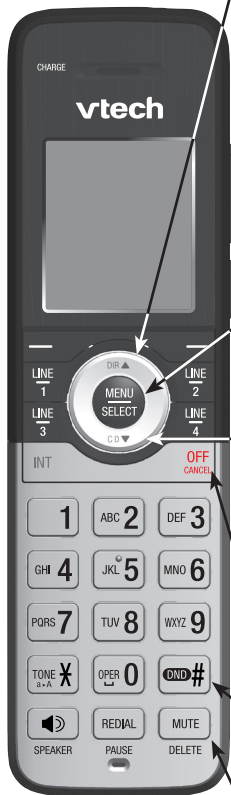

DIR▲

- Press to scroll up while in menus.
- Press to show directory entries when the telephone is not in use.

-/VOLUME/+

- During a call, press to adjust the listening volume.
- Press to adjust the ringer volume when in idle mode.

PAGE

- Press to begin a one-to-one or one-to-group broadcast.

MENU/SELECT

- Press to enter the menu.
- While in a menu, press to select an item or save an entry or setting.

CID▼

- Press to scroll down while in menus.
- Press to show the caller ID history when the telephone is not in use.

OFF/CANCEL

- While using menus, press to return to idle mode.
- During a call, press to hang up.

DND (Do not disturb)

- In idle mode, press and hold to MUTE the feature on. Press and hold again to turn off.

MUTE/DELETE

- During a call, press to mute the microphone.
- While predialing, press to delete digits.
- While reviewing the directory entry, press to delete an individual entry.
- While entering or editing a directory entry, press to erase a digit or character. Press and hold to erase all digits or characters.

Getting started

Handset overview

Menus



Answering system menu

- Play messages
- Mailbox On/Off
- Record memo
- Gen MB
- Settings
- Remaining time
- Delete all old

Main menu

- Directory
- Call history
- Ringer setting
- Handset setup
- Speed dial
- User support
- Handset info
- Factory reset

Using menus

- Press **MENU/SELECT** to show the main menu; or press **M.Box** to show the answering system menu.
- Press **▲DIR** or **▼CID** to scroll through menu items.
- Press **MENU/SELECT** or **Select** to select or save changes to a highlighted menu item.
- Press **OFF/CANCEL** or **Back** to cancel an operation, exit the menu display or return to the idle screen.

Getting started

Handset overview

The following tables provides you with more details on the main menu and the answering system menu of the handset.

Table 1 - Main menu (Press MENU/SELECT in idle screen)

Menu	Description	Reference
Directory	Review, add or delete directory entries.	Pages 48-52
Call history	Review, delete call history entries, or copy an entry to directory.	Pages 53-59
Ringer setting	Set ringer volume and ring tone for an incoming call.	Pages 20-21
Handset setup	Set LCD contrast, key tone, auto key lock, language, Primary line*, call privacy**, handset name, and hold remainder. *Primary line defines which line is automatically selected each time you pick up the corded handset or press the speakerphone. **Call privacy defines whether other extensions can barge in to join a call in progress.	Pages 22-25
Speed dial	Program the desired telephone numbers or extension numbers into the speed dial keys.	Pages 46-47
User support	Display a website for you to get extra support.	Page 26
Handset info	Display ring group status, and the extension number of a paired accessory.	Page 26
Factory reset	Reset all settings of the handset to the factory default.	Page 26

Getting started

Handset overview

Table 2 - Answering system menu (Press left softkey in idle screen)

Menu	Description	Reference
Play messages	Play messages in the private mailbox.	Pages 68-69
Mailbox On/Off	Turn on or off the private mailbox, or set to play an announcement only to caller when no one is available to pick up the call.	Page 60
Record memo	Record reminders for yourself or others who are using the same telephone system.	Page 71
Gen MB	Play or delete messages in the general mailbox.	Pages 68-69
Settings	<p>Set up the handset's private mailbox.</p> <p>Mailbox On, Announce only - Set the number of rings before the system answers the incoming calls, and record your own greeting announcements.</p> <p>Remote access - Modify the passcode for users to access private mailbox remotely by making a call to one of the telephone lines.</p> <p>Message length - Set the maximum duration allowed for any voice messages.</p>	Pages 61-66

Getting started





Handset overview

Table 2 - Answering system menu (Press left softkey in idle screen) (Continued)

Menu	Description	Reference
Settings (Continued)	<p>Call screening - Set whether the handset user hear the caller whenever a voice recording is taking place.</p> <p>Call intercept - Set whether users of other system extensions can intercept and stop a recording in private mailbox and talk to the caller.</p> <p>Msg alert tone - Set whether a tone is played in idle mode when there are unattended messages in the private mailbox.</p>	Pages 61-66
Remaining time	Check the remaining recording time and number of messages available in the private mailbox.	Page 66
Delete all old	Delete all old messages in the private mailbox.	Page 70

Getting started

Handset screen icons

	On when any corresponding extensions are in use.
L1 L2 L3 L4	On when the telephone line is in use by another extension. Flashes slowly when the telephone line is on hold by another extension.
	Ringer off - On steadily when the ringer volume is set to OFF or the do not disturb function is on.
	Headset - On steadily when using a corded headset.
	Battery indicator - Shows the battery status.
-Mute	Microphone is muted.
-Priv	On steadily when the call privacy feature is set to On .
-Recording call	On steadily when recording a call.
Conf.	On steadily during a conference call.

Getting started

Alert tones and lights

Handset alert tones

One beep	The handset is recording an announcement or memo.
Two beeps	You have set the hold reminder on; a call has been on hold for more than three minutes. -OR- You have set the message alert tone on. -OR- There is an incoming call waiting.

Handset indicator lights

Charge light

- On when the handset is charging in the charger.

Large Lighted Display

LINE 1/LINE 2/LINE 3/LINE 4

- On when the telephone line is in use.
- Flashes slowly when the telephone line is on hold.
- Flashes quickly when there is an incoming call.

INT

- On when the handset is on an intercom call.
- Flashes slowly when an intercom call is on hold.
- Flashes quickly when there is an incoming intercom call.

Backlight (lighted display and dial pad)

- On when the handset is lifted from the charger.
- On when a key is pressed.

SPEAKER light

- On when the speakerphone is in use.

Telephone settings

Telephone setup

Menu settings

Use this menu to change the handset settings.

1. Press **MENU/SELECT** when in idle mode (when the handset is not in use) to enter the main menu.
2. Press **▲DIR** or **▼CID** to scroll to the feature to be changed. The > symbol indicates the selected menu item.
3. Press **MENU/SELECT** or the **Select** softkey to select the menu item.
4. Press **Back** to exit setup without making changes.
5. Press **OFF/CANCEL** to back to the idle mode.



NOTE: Press **OFF/CANCEL** to cancel an operation, exit the menu display, or return to idle mode.

Telephone settings

Telephone setup

Ringer volume

Use this feature to set the ringer volume to one of six levels or turn the ringer off. When the ringer is off, the  icon appears on the handset screen. The handset stores the volume setting for all lines.

1. When the handset is idle, press **MENU/SELECT**.
2. Press **▲DIR** or **▼CID** to scroll to **Ringer setting**, then press **MENU/SELECT** or **Select**.
3. Press **MENU/SELECT** or **Select** again to select **Ringer volume**.
4. Press **▲DIR**, **▼CID** or **-/VOLUME/+** on the handset to adjust the ringer volume.
5. Press **MENU/SELECT** or **Save** to save the setting and return to the previous menu. There is a confirmation tone. To exit without making changes, press **OFF/CANCEL** or **Back**.

-OR-

When the handset is idle, press **-/VOLUME/+** to adjust the ringer volume, then press **MENU/SELECT** or **Save** to save.



NOTE: The ringer volume also determines the ringer volume for intercom calls. If the handset ringer volume is set to off, the handset is silenced for all incoming calls, including intercom calls.

Telephone settings

Telephone setup

Ringer tone

Use this feature to choose one of the ten ringer tones. You can choose different ringer tones for different lines so you can easily identify which line is calling.

1. When the handset is idle, press **MENU/SELECT**.
2. Press **▲DIR** or **▼CID** to scroll to **Ringer setting**, then press **MENU/SELECT** or **Select**.
3. Press **▲DIR** or **▼CID** to scroll to **Ringer tone**, then press **MENU/SELECT** or **Select**.
4. Press **▲DIR** or **▼CID** to select the desired line (**Line 1**, **Line 2**, **Line 3** or **Line 4**), then press **MENU/SELECT** or **Select**.
5. Press **▲DIR** or **▼CID** to select a desired ringer tone.
6. Press **MENU/SELECT** or **Select** to save the setting and return to the previous menu. There is a confirmation tone. To exit without making changes, press **OFF/CANCEL** or **Back**.
7. Repeat steps 4-6 above to choose ringer tones for other lines if desired.

Do not disturb (DND)

Use this feature to silence your handset. When you activate the do not disturb function, the  icon and **Do Not Disturb** appear on the handset screen. You will not receive any paging call and you will not hear rings of incoming call or intercom call.

Instead, the **LINE 1-LINE 4** indicator flashes to signal an incoming call. If you receive an intercom call, the extension number of that intercom call appears on the screen display.

1. In idle mode, press and hold **DND** to prevent interruptions. The  icon and **Do Not Disturb** appear on the screen.
2. In idle mode, press and hold **DND** again to resume normal call alerts.

Telephone settings

Telephone setup

LCD contrast

Use this feature to adjust the screen contrast to one of five levels to optimize readability in different lighting conditions.

1. When the handset is idle, press **MENU/SELECT**.
2. Press **▲DIR** or **▼CID** to scroll to **Handset setup**, then press **MENU/SELECT** or **Select**.
3. Press **MENU/SELECT** or **Select** again to select **LCD contrast**.
4. Press **▲DIR**, **▼CID** or **-/VOLUME/+** to adjust the screen contrast level (**Level 1 - Level 5**).
5. Press **MENU/SELECT** or **Save** to save the setting and return to the previous menu. You hear a confirmation tone. To exit without making changes, press **OFF/CANCEL** or **Back**.

Key tone

The handset is set to beep with each key press. If you turn off the key tone, there are no beeps when you press keys.

1. When the handset is idle, press **MENU/SELECT**.
2. Press **▲DIR** or **▼CID** to scroll to **Handset setup**, then press **MENU/SELECT** or **Select**.
3. Press **▲DIR** or **▼CID** to scroll to **Key tone**, then press **MENU/SELECT** or **Select**.
4. Press **▲DIR** or **▼CID** to scroll to **On** or **Off**.
5. Press **MENU/SELECT** or **Select** to save the setting and return to the previous menu. You hear a confirmation tone. To exit without making changes, press **OFF/CANCEL** or **Back**.

Telephone settings

Telephone setup

Auto key lock

Use this feature to prevent accidental dialing while carrying the handset around. When auto key lock is on, the handset will lock the keypad automatically after 30 seconds in idle mode.

1. When the handset is idle, press **MENU/SELECT**.
2. Press **▲DIR** or **▼CID** to scroll to **Handset setup**, then press **MENU/SELECT** or **Select**.
3. Press **▲DIR** or **▼CID** to scroll to **Auto key lock**, then press **MENU/SELECT** or **Select**.
4. Press **▲DIR** or **▼CID** to scroll to **On** or **Off**.
5. Press **MENU/SELECT** or **Select** to save the setting and return to the previous menu. You hear a confirmation tone. To exit without making changes, press **OFF/CANCEL** or **Back**.



NOTES:

- To manually lock and unlock the keypad, see page 28.
- When the handset keypad is locked and there is an incoming call on a line, you cannot answer the call if the handset does not belong to the line's ring group. Refer to **Handset information** on page 26 to see which ring group(s) it belongs to.

LCD Language

This feature allows you to change the language used for handset displays. By default, the language is set to **English**.

1. When the handset is idle, press **MENU/SELECT**.
2. Press **▲DIR** or **▼CID** to scroll to **Handset setup**, then press **MENU/SELECT** or **Select**.
3. Press **▲DIR** or **▼CID** to scroll to **Language**, then press **MENU/SELECT** or **Select**.
4. Press **▲DIR** or **▼CID** to scroll to **English**, **Français** or **Español**.
5. Press **MENU/SELECT** or **Select** to save the setting and return to the previous menu. You hear a confirmation tone. To exit without making changes, press **OFF/CANCEL** or **Back**.

Telephone settings

Telephone setup

Primary line

Use this feature, also known as automatic line selection, to choose which line is automatically selected each time you make an outside call. If you select **Auto**, the handset picks up any available line starting from Line 1.

1. When the handset is idle, press **MENU/SELECT**.
2. Press **▲DIR** or **▼CID** to scroll to **Handset setup**, then press **MENU/SELECT** or **Select**.
3. Press **▲DIR** or **▼CID** to scroll to **Primary line**, then press **MENU/SELECT** or **Select**.
4. Press **▲DIR** or **▼CID** to scroll to a desired line.
5. Press **MENU/SELECT** or **Select** to save the setting and return to the previous menu. You hear a confirmation tone. To exit without making changes, press **OFF/CANCEL** or **Back**.

Call privacy

The call privacy is set to **Off** by default. The handset allows other extensions to join a call in progress. You can turn this setting on to ensure that only one device uses a line at a time.

1. When the handset is idle, press **MENU/SELECT**.
2. Press **▲DIR** or **▼CID** to scroll to **Handset setup**, then press **MENU/SELECT** or **Select**.
3. Press **▲DIR** or **▼CID** to scroll to **Call privacy**, then press **MENU/SELECT** or **Select**.
4. Press **▲DIR** or **▼CID** to scroll to **On** or **Off**.
5. Press **MENU/SELECT** or **Select** to save the setting and return to the previous menu. You hear a confirmation tone. To exit without making changes, press **OFF/CANCEL** or **Back**.



NOTE: To temporarily change the call privacy setting during a call, see page 31.

Telephone settings

Telephone setup

Hold reminder

When the handset holds an outside call or an intercom call for more than three minutes, it gives you a double beep every 30 seconds. You can set its volume to one of six levels or turn the reminder off.

1. When the handset is idle, press **MENU/SELECT**.
2. Press **▲DIR** or **▼CID** to scroll to **Handset setup**, then press **MENU/SELECT** or **Select**.
3. Press **▲DIR** or **▼CID** to scroll to **Hold reminder**, then press **MENU/SELECT** or **Select**.
4. Press **▲DIR**, **▼CID** or **-/VOLUME/+** on the handset to adjust the beep volume.
5. Press **MENU/SELECT** or **Save** to save the setting and return to the previous menu. You hear a confirmation tone. To exit without making changes, press **OFF/CANCEL** or **Back**.

Handset name

Use this feature to rename the handset.

1. When the handset is idle, press **MENU/SELECT**.
2. Press **▲DIR** or **▼CID** to scroll to **Handset setup**, then press **MENU/SELECT** or **Select**.
3. Press **▲DIR** or **▼CID** to scroll to **Handset name**, then press **MENU/SELECT** or **Select**.
4. Use the dialing keys to change the name (up to 10 characters).
 - Press **▲DIR** or **▼CID** to move the cursor left or right.
 - Press **MUTE/DELETE** to delete a character.
 - Press and hold **MUTE/DELETE** to delete all characters.
5. Press **MENU/SELECT** or **Save** to save the setting and return to the previous menu. You hear a confirmation tone. To exit without making changes, press **OFF/CANCEL** or **Back**.

Telephone settings

Telephone setup

Factory reset

Use this feature to reset all settings of this handset to their default settings. All phone settings, directory, caller ID history, redial list, speed dial memory, private mailbox messages will be reset.

Make sure the telephone system is idle before you reset the handset.

1. When the handset is idle, press **MENU/SELECT**.
2. Press **▲DIR** or **▼CID** to scroll to **Factory reset**, then press **MENU/SELECT** or **Select**.
3. The handset displays **Are you sure to reset handset?**. Press **Yes** to confirm and then return to the previous menu. To exit without making changes, press **OFF/CANCEL** or **No**.

Handset information

This feature displays the ring group status of the handset, and the extension number of an accessory paired to the handset.

Ring group defines if the handset will ring when there is an incoming call at the corresponding line. To change the setting and for more details, refer to the **Ring group** section in the user's manual of **CM18445** console.

1. When the handset is idle, press **MENU/SELECT**.
2. Press **▲DIR** or **▼CID** to scroll to **Handset info**, then press **MENU/SELECT** or **Select**.
3. Press **OFF/CANCEL** or **OK** to return to the previous menu.

User support

Use this feature to display the VTech website.

1. When the handset is idle, press **MENU/SELECT**.
2. Press **▲DIR** or **▼CID** to scroll to **User support**, then press **MENU/SELECT** or **Select**.
3. Press **OFF/CANCEL** or **OK** to return to the previous menu.

Telephone operation

Telephone operation

Line indicators

Each of the four indicators on **LINE 1-LINE 4** indicate the state of the corresponding telephone line.

- On when the corresponding line is in use on this handset.
- Flashes when there is an incoming call on the corresponding line.



Making and ending a call

To make a call:

1. Press the desired line key (**LINE 1-LINE 4**).
2. Wait for a dial tone, then enter the telephone number. The screen displays the elapsed time as you talk (in hours, minutes and seconds).

To end a call:

Press **OFF/CANCEL** or return the handset to the charger to hang up.



NOTE: The elapsed time is not affected by accessing services from your telephone service provider.

On hook dialing (predialing)

1. Enter the telephone number. Press **MUTE/DELETE** to make corrections.
2. Press the desired line key **LINE 1-LINE 4** to dial the call.

Telephone operation

Telephone operation

Using the speakerphone

During a call, press **☎/SPEAKER** to switch between handsfree speakerphone and normal handset use. Press **OFF/CANCEL** to hang up.

Answering a call

Press any line key (**LINE 1-LINE 4**).

-OR-

Press **☎/SPEAKER** on the handset to answer using the speakerphone.

Temporary ringer silencing

When the telephone is ringing, you can temporarily silence the ringer of the handset without disconnecting the call. Press **MUTE/DELETE** to silence the ringer. The next call rings normally at the preset volume.

Lock keypad

While the handset is idle, press **Lock** and then **OK** to lock the keypad. You hear a confirmation tone.

Press **Unlock** and then **OK** to unlock the keypad.



NOTE: When the handset keypad is locked and there is an incoming call on a line, you cannot answer the call if the handset does not belong to the line's ring group. Refer to **Handset information** on page 26 to see which ring group(s) it belongs to.

Telephone operation

Options while on calls

Call waiting

If you subscribe to call waiting service with your telephone service provider, you hear two beeps if someone calls while you are on a call.

- Press **Flash** to put your current call on hold and take the new call.
- Press **Flash** at any time to switch back and forth between calls.

Volume control

Use this feature to set the listening volume to one of six levels for the handset and speakerphone. While on a call, press **-/VOLUME/+** to adjust the listening volume.



NOTE: Handset and speakerphone volume settings are independent.

Mute

Use this feature during a telephone conversation to silence the microphone. You can hear the caller, but the caller cannot hear you.

To mute a call:

- Press **MUTE/DELETE**. When mute is on, the screen displays **-Mute**.

To take a call off mute:

- Press **MUTE/DELETE** again and resume speaking.



Telephone operation

Options while on calls

Hold

Use this feature to hold one line while accessing another, or as part of the conference.

While on a call, press **Hold**. The corresponding line key (**LINE 1-LINE 4**) indicator for the line on hold flashes slowly. After the call has been put on hold for more than three minutes, you hear a double beeps every 30 seconds. (To adjust the volume or turn off the reminder beep, see **Hold reminder** on page 25).

If you are using the speakerphone, the speakerphone turns off automatically when you press **Hold**.

To release the hold, press the corresponding line key.

Music on hold (M.O.H) feature is available. When you put a call on hold, the caller will hear the music that comes with the telephone system. To change the setting and for more details, refer to the **Music on hold** section in the user's manual of **CM18445** console.



NOTES:

- The call privacy setting in **Handset setup** menu remains unchanged after the call is put on hold.
- The call ends automatically after it is put on hold for 15 minutes.

Switching between lines

Use this feature to switch between lines during an outside call:

1. Press the desired line key (**LINE 1-LINE 4**) of another telephone line to make or answer another call. The current call is put on hold automatically.
2. To return to the first call, press the line key (**LINE 1-LINE 4**) of the original call. The second line is put on hold automatically.



NOTE: Source of music files: FreeMusicArchive.org. Used under open license.

Telephone operation

Options while on calls

Call privacy

During a call, you can temporarily change the call privacy setting to allow or disallow other extensions to join the call. The original setting is automatically restored after you hang up or resume the call you put on hold.

To turn call privacy off during a call:

1. During the call, press **MENU/SELECT**.
2. Press **▲DIR** or **▼CID** to scroll to **Private**, then press **MENU/SELECT** or **Select**.

Other extensions can now join the call by pressing the corresponding line key (**LINE 1-LINE 4**).

To turn call privacy back on during a call:

1. During the call, press **MENU/SELECT**.
2. Press **▲DIR** or **▼CID** to scroll to **Private**, then press **MENU/SELECT** or **Select**. The handset displays **-Priv**.

No extension can join the call now. If another extension tries to access the line you are using, it displays **Private call**.



NOTE: To set call privacy for every incoming and outgoing call, see page 24.

Telephone operation

Options while on calls

Recording a call

Use this feature to record a phone conversation during a call. The recording is treated the same as memos and is marked as a new message in the private mailbox. Listen to recorded conversation the same way as incoming messages or memos (see **Message playback** on page 68).

To record a call:

1. During the call, press **MENU/SELECT**.
2. Press **MENU/SELECT** or **Select** to start recording.
3. The recording starts and the screen shows **-Recording call**. Both the handset user and the far-end party hear a beep sound.



NOTE: To ensure that you are in compliance with any federal or state regulations regarding recording a telephone call, you should start the recording process and then inform the other party that you are recording the call.

To stop recording:

Press **OFF/CANCEL** or return the handset to the charger to hang up.

-OR-

1. During the call, press **MENU/SELECT**.
2. Press **MENU/SELECT** or **Select** to stop recording. The system saves the conversation into the private mailbox.

Telephone operation

Options while on calls

Chain dialing

While you are on a call, you can initiate a dialing sequence from the numbers in the directory, caller ID history or redial list.

Chain dialing can be useful if you wish to access other numbers (such as bank account numbers or access codes) from the directory, caller ID history or redial list

To access the directory while on a call:

1. Press **▲DIR**, then press **▲DIR** or **▼CID** to scroll to the desired entry.
2. Press **MENU/SELECT** to dial the desired number. To exit without making changes, press **Back** and continue with the conversation.

To access the call history while on a call:

1. Press **▼CID**, then press **▲DIR** or **▼CID** to scroll to the desired entry.
2. Press **MENU/SELECT** to dial the desired number. To exit without making changes, press **Back** and continue with the conversation.

To access the redial list while on a call:

1. Press **REDIAL/PAUSE**, then press **▲DIR** or **▼CID** to scroll to the desired entry.
2. Press **MENU/SELECT** to dial the desired number. To exit without making changes, press **Back** and continue with the conversation.

Telephone operation

Redial

The last 10 telephone numbers dialed (up to 32 digits) are stored in your handset.

To view and dial the 10 most recently dialed numbers:

1. Press **REDIAL/PAUSE** to enter the redial list and display the most recently called number.
2. Press **▲DIR** or **▼CID** to view the last 10 called numbers.
3. Press **OFF/CANCEL** to exit the redial list.

To redial a number:

When the desired number displays on the screen, press a desired line key (**LINE 1-LINE 4**) or **◀▶/SPEAKER** to dial.

To copy a redial entry to directory:

1. Press **REDIAL/PAUSE** to enter the redial list and display the most recently called number.
2. Press **▲DIR** or **▼CID** to scroll to the desired redial number.
3. Press **Add**. The handset displays **Edit number**. Use the dialing keys to edit the number.
 - Press **MUTE/DELETE** to delete a digit.
 - Press and hold **MUTE/DELETE** to delete all digits.
 - Press **▲DIR** or **▼CID** to move the cursor to the left or right.
4. Press **MENU/SELECT** or **Save** to proceed. The handset displays **Enter name**. Use the dialing keys to enter the name.
 - Press **MUTE/DELETE** to delete a character.
 - Press and hold **MUTE/DELETE** to delete all characters.
 - Press **▲DIR** or **▼CID** to move the cursor to the left or right.
 - Press and hold **0** to add a space.
5. Press **MENU/SELECT** or **Save** to save. The handset displays **Contact saved**, and then you hear a confirmation tone.

Telephone operation

Redial

To delete a redial number:

While the screen displays the desired number, press **MUTE/DELETE** to delete the number from the redial memory. You hear a confirmation tone.

Telephone operation

Conference call

The system can support 6-party conference with a maximum of four outside calls and two system extensions (including the initiating party).

Establish a conference call

There are two ways to establish a conference call.

A. Hold an intercom call

After establishing an intercom call with another system extension, the initiating party holds the intercom call and invites an external party to join the conference by making an outside call.

1. Press **INT**. Press **▲DIR** or **▼CID** to scroll to the desired extension, then press **MENU/SELECT** or **Select**. The called extension picks up the intercom call, and the outside call is put on hold.

-OR-

Press and hold the speed dial key assigned with the desired extension number. The called extension picks up the intercom call.

2. Press another available line key to make an outside call. The original intercom call is put on hold. When the external party picks up, you can have a private conversation with that party.
3. Press **MENU/SELECT**, then press **▲DIR** or **▼CID** to scroll to **Conference**. Press **MENU/SELECT** again or **Select** to begin the conference call.
4. If necessary, repeat step 2 and step 3 above to invite another external party to join the conference until the maximum capacity is reached.

Telephone operation

Conference call

B. Hold an outside call or join a call in progress

After establishing the first outside call, the party can invite another system extension to join the conference by using intercom.

Any system extension can also join a call in progress by pressing the line key which is currently in use to set up a conference.

1. Make or answer an outside call.
2. Press another available line key to make another outside call. The original outside call is put on hold. When the external party picks up, you can have a private conversation with that party.

-OR-

Press **INT**. Press **▲DIR** or **▼CID** to scroll to the desired extension, then press **MENU/SELECT** or **Select**. The called extension picks up the intercom call, and the outside call is put on hold.

-OR-

Any system extension can press the line key currently in use to create a conference with the console and the external party.

- If the call privacy of your handset is set to **On**, follow the instructions of **To turn call privacy off during a call** on page 31 to turn off the setting temporarily.
3. Press **MENU/SELECT**, then press **▲DIR** or **▼CID** to scroll to **Conference**. Press **MENU/SELECT** or **Select** to begin the conference call.
 4. If necessary, repeat step 2 (make another outside call) and step 3 to invite another external party to join the conference until the maximum capacity is reached.



NOTES:

- After a conference call is established, other extensions are not allowed to join the conference in progress.
- The flash signal in a dialing sequence is not available during a conference call.
- The system does not support an internal conference of more than two system extensions.

Telephone operation

Conference call

Options during a conference call

To talk privately with one external party:

1. Press **LINE 1-LINE 4** to talk privately with the person on that line. The intercom call is automatically placed on hold.
2. Press **MENU/SELECT**, then press **▲DIR** or **▼CID** to scroll to **Conference**. Press **MENU/SELECT** again or **Select** to resume the conference call.

To talk privately with one internal party:

1. Press **INT** to talk privately with the person on that extension. The external line(s) is/are automatically placed on hold.
2. Press **MENU/SELECT**, then press **▲DIR** or **▼CID** to scroll to **Conference**. Press **MENU/SELECT** again or **Select** to resume the conference call.

To drop an outside line:

1. Press **MENU/SELECT**.
2. Press **MENU/SELECT**, then press **▲DIR** or **▼CID** to select **End line**.
3. Press **▲DIR** or **▼CID** to choose the line number that you want to drop.
4. Press **MENU/SELECT** to confirm.

To drop an intercom call:

1. Press **INT** to activate the intercom call that you want to drop. The external line(s) is/are automatically placed on hold. Press **OFF/CANCEL**.

If there is only one external line on hold, press **LINE 1-LINE 4** to resume the external call.

If there is multiple external lines on hold, press a desired line key, and then press **MENU/SELECT**. Press **▲DIR** or **▼CID** to scroll to **Conference**, then press **MENU/SELECT** again or **Select** to resume the conference call.

Telephone operation

Conference call

To end a conference call:

- Press **OFF/CANCEL** or return the handset to the charger to hang up. The call will be ended when all parties hang up.

Telephone operation

Intercom

You can use the intercom feature for conversations between the handset and other system devices.

Make an intercom call to an extension

1. Press **INT** on the handset when it is idle.
2. Press **▲DIR** or **▼CID** to scroll to a desired extension, then press **MENU/SELECT** or **Select**.
3. The handset displays **Calling: XX** (**XX** represents the name and extension number of destination device).

-OR-

If you have assigned extension numbers as speed dial entries (see **Assign a speed dial entry** on pages 41-42), you can initiate an intercom by pressing the desired speed dial key.



NOTES:

- Before the intercom call is answered, you can cancel the intercom by pressing **OFF/CANCEL**.
- You cannot intercom an extension that is on an intercom call.

Answer an intercom call

When you receive an intercom call, you hear a ringing tone and the handset displays **---Intercom--- XX** (**XX** represents the extension number of the calling device). Press **INT** or **🔊/SPEAKER** to answer.

End an intercom call

Press **OFF/CANCEL** to hang up.

Telephone operation

Intercom

Answer an incoming call during an intercom call

If you receive an incoming outside call during an intercom call, there is an alert tone.

To answer the call, press the corresponding line key (**LINE 1-LINE 4**). The intercom call is put on hold automatically.

Hold an intercom call

During an intercom call, press **Hold**.

After the call has been put on hold for more than three minutes, a double beep sounds every 30 seconds. To turn off the reminder beep, see **Hold reminder** on page 25.

The far end of the held intercom call will hear the music that comes with the telephone system. To change the setting and for more details, refer to the **Music on hold** section in the user's manual of **CM18445** console.



NOTES:

- You can only hold one pair of intercom call.
- The intercom call on hold is dropped after 15 minutes.

Handle an intercom call by the private mailbox

When the handset receives an intercom call and there is no answer after the programmed number of rings (see **Number of rings** on page 61), the caller is prompted to leave a message in the private mailbox.

Telephone operation

Call transfer

You can transfer a call to any other system telephone. Only the recipient extension can answer the transferred call.

Blind transfer

While on a call, you can transfer a call directly without notifying the desired extension:

1. During the call, press **MENU/SELECT**.
2. Press **▲DIR** or **▼CID** to scroll to **Transfer**, then press **MENU/SELECT** or **Select**.
3. Press **▲DIR** or **▼CID** to scroll to the desired extension, then press **MENU/SELECT** or **Select**.
4. The destination device rings. Choose either option below.
 - Answer the call at the destination device.
 - You can resume the call by pressing the corresponding flashing line key (**LINE 1-LINE 4**) on the handset before the destination device answers the call.
5. Press **OFF/CANCEL** or return the handset to the charger to hang up.

Transfer a call and speak to the receiving party

You can transfer a call and speak to the receiving party before completing the transfer while on a call:

1. Press **INT** on the handset while on a call.
2. Press **▲DIR** or **▼CID** to scroll to a desired extension, then press **MENU/SELECT** or **Select**. The outside call is put on hold.
3. When the destination party answers the call, you can then talk to the destination party privately.
4. Press **MENU/SELECT**, then press **▲DIR** or **▼CID** to scroll to **Transfer**.
5. Press **MENU/SELECT** or **Select** to transfer the call to the destination extension. The handset returns to idle.

Telephone operation

Paging

You can directly broadcast your voice to the speakerphone of the console, any deskset and handset. The extension you called can respond by pressing the **PAGE** key to begin a two-way communication.

Make a paging call to an extension

1. Press **PAGE** on the handset when it is idle.
2. Press **▲DIR** or **▼CID** to scroll to a desired extension, then press **MENU/SELECT** or **Select**. The screen displays **Paging...**, then **Press and hold [PAGE] to talk**.
3. Press and hold the **PAGE** key until the handset displays **Paging...**
4. Speak towards the microphone while continuing to hold down the **PAGE** key. Your voice is broadcast to the desired extension.
5. Release the **PAGE** key after speaking. The destination party can reply.



NOTES:

- Before the paging call is answered, you can cancel the paging by pressing **CANCEL**.
- You cannot page an extension that is on a call.
- If all four telephone lines are in use, the paging feature is not available.

Telephone operation

Paging

Set and edit a group for paging call

Use the group setting if you want to broadcast your voice to a group of extensions. When you page a group, only the selected extensions hear your voice. You can create up to three paging groups.

1. Press **PAGE** on the handset when it is idle.
2. Press **▲DIR** or **▼CID** to scroll to **Group**, press **MENU/SELECT** or **Select**.
3. Press **▲DIR** or **▼CID** to scroll to **Define groups**, press **MENU/SELECT** or **Select**.
4. Press **▲DIR** or **▼CID** to scroll to a desired group (**Group 1-Group 3**), press **MENU/SELECT** or **Select**.
5. Press an extension number if you want to add it into the group.
 - To remove an extension number, press the same number again.
6. Press **MENU/SELECT** or **Save**, to save the setting and return to the previous menu. To exit without making changes, press **OFF/CANCEL** or **Back**.



NOTE: Each group can contain a maximum of four other system extensions.

Telephone operation

Paging

Make a paging call to multiple extensions

1. Press **PAGE** on the handset when it is idle.
2. Press **▲DIR** or **▼CID** to scroll to **Group** or **All**, press **MENU/SELECT** or **Select**.
 - If you choose **Group**, press or to scroll to a desired group of extensions. Then, press **MENU/SELECT** or **Select**.

The screen displays **Paging...**, then **Press and hold [PAGE] to talk**.

3. Press and hold the **PAGE** key until the handset displays **Paging...**
4. Speak towards the microphone while continuing to hold down the **PAGE** key. Your voice is broadcast to the desired extension.
5. Release the **PAGE** key after speaking. Any destination party can reply.



NOTES:

- Paging all extensions will create a paging call that only involves the console and the first other four system devices.
- If any of the console and the first other four system devices is busy, it will not receive the paging call.

End a paging call

Press **OFF/CANCEL** to end the paging call.

Delete the group settings

1. Press **PAGE** on the handset when it is idle.
2. Press **▲DIR** or **▼CID** to scroll to **Group**, press **MENU/SELECT** or **Select**.
3. Press **▲DIR** or **▼CID** to scroll to **Clear groups**, press **MENU/SELECT** or **Select**.
4. The handset displays **Clear all group settings?**. Press **MENU/SELECT** or **Yes** to confirm your choice. To exit without making changes, press **OFF/CANCEL** or **No**.

Telephone operation

Speed dial

This handset has 10 speed dial locations where you can store and dial phone numbers or system extension numbers. You can store up to 32 digits in each location.



NOTE: By default, pressing speed dial keys 0 to 9 will make an intercom call to the corresponding registered extension.

Assign a speed dial entry

Use the following steps to program the speed dial keys.

To copy entry from directory or select an extension:

1. When the handset is idle, press **MENU/SELECT**.
2. Press **▲DIR** or **▼CID** to scroll to **Speed dial**, then press **MENU/SELECT** or **Select**.
3. Press the desired speed dial key (**0-9**), then press **MENU/SELECT** or **Edit**.
4. Press **▲DIR** or **▼CID** to scroll to **Add from DIR** or **Call extension**, then press **MENU/SELECT** or **Select**.
5. Press **▲DIR** or **▼CID** to choose a desired entry.
6. Press **MENU/SELECT** or **Select** to save the setting. To exit without making changes, press **OFF/CANCEL** or **Back**.

To add a new phone number:

1. When the handset is idle, press **MENU/SELECT**.
2. Press **▲DIR** or **▼CID** to scroll to **Speed dial**, then press **MENU/SELECT** or **Select**.
3. Press the desired speed dial key (**0-9**), then press **MENU/SELECT** or **Edit**.
4. Press **MENU/SELECT** or **Select** to choose **New number**.
5. Use the dialing keys to enter the number (up to 32 digits).
 - Press **MUTE/DELETE** to delete a digit.
 - Press and hold **MUTE/DELETE** to delete all digits.
 - Press **▲DIR** or **▼CID** to move the cursor to the left or right.

Telephone operation

Speed dial

6. Press **MENU/SELECT** or **Save**.
 - The display shows **Number already saved** if the number is already in the directory. Go to the previous step and choose **Add from DIR** to assign the speed dial entry.
7. The handset displays **Enter name**. Use the dialing keys to enter the name (up to 24 characters).
 - Press **MUTE/DELETE** to delete a character.
 - Press and hold **MUTE/DELETE** to delete all characters.
 - Press **▲DIR** or **▼CID** to move the cursor to the left or right.
 - Press and hold **0** to add a space.
8. Press **MENU/SELECT** or **Save**. To exit without making changes, press **OFF/CANCEL**.



NOTES:

- The newly added phone number will also be saved to the directory.
- If you want to edit the phone number of the speed dial entry, you need to edit it in directory.

Dial a speed dial entry

When the handset is idle, press and hold the desired speed dial key (**0-9**).

Delete a speed dial entry

1. When the handset is idle, press **MENU/SELECT**.
2. Press **▲DIR** or **▼CID** to scroll to **Speed dial**, then press **MENU/SELECT** or **Select**.
3. Press the desired speed dial key (**0-9**), then press **MUTE/DELETE**.



NOTES:

- Deleting a speed dial entry will not delete the corresponding entry in the directory.
- If you delete the speed dial entry for keys 0 to 9, it will reset to the default setting and serve as an intercom key to the corresponding registered extension.

Directory

About the directory

Use the directory to store names and phone numbers. Directory entries are not shared with other extensions. The console and each deskset have their own directories.

Capacity

The directory of this handset can store up to 100 entries, with a maximum of 24 alphanumeric characters (including spaces) for names and 32 digits for telephone numbers. A convenient search feature can help you quickly find and dial numbers (page 51).

If there are already 100 entries, the handset shows **Directory full** when you try to create a new directory entry. You cannot store a new number until you delete one. If you try to view the directory when there are no entries, the screen displays **Directory empty**.

Exit the directory

On the handset, press **OFF/CANCEL** to cancel an operation and return to idle mode.

Directory

Create directory entries

Create a new directory entry

Use the following steps to store a name and number in the directory.

1. When the handset is idle, enter the telephone number (up to 32 digits).
2. Press **MENU/SELECT** or **Add**. Use the dialing keys to edit the number, if necessary.
 - Press **MUTE/DELETE** to delete a digit.
 - Press and hold MUTE/DELETE to delete all digits.
 - Press **▲DIR** or **▼CID** to move the cursor to the left or right.
3. Press **MENU/SELECT** or **Save**. The handset displays **Enter name**. Use the dialing keys to enter the name (up to 24 characters).
 - Press **MUTE/DELETE** to delete a character.
 - Press and hold MUTE/DELETE to delete all characters.
 - Press **▲DIR** or **▼CID** to move the cursor to the left or right.
 - Press and hold 0 to add a space.
4. Press **MENU/SELECT** or **Save**.

-OR-

1. When the handset is idle, press **MENU/SELECT**.
2. Press **MENU/SELECT** or **Select** to choose **Directory**.
3. Press **▲DIR** or **▼CID** to scroll to **Add contact**, then press **MENU/SELECT** or **Select**.
 - If the directory is empty, press **Add**.
4. The screen displays **Enter number**. Use the dialing keys to enter the number (up to 32 digits).
5. Press **MENU/SELECT** or **Save**. The handset displays **Enter name**. Use the dialing keys to enter the name (up to 24 characters).
6. Press **MENU/SELECT** or **Save**. To exit without making changes, press **OFF/CANCEL**.

Directory

Create directory entries

Review directory entries

1. When the handset is idle, press **▲DIR**. The screen displays the first entry in the directory.
2. Press **▲DIR** or **▼CID** to browse through the directory. Entries appear alphabetical order.
3. Press **OFF/CANCEL** to return to idle mode.

-OR-

1. When the handset is idle, press **MENU/SELECT**.
2. Press **MENU/SELECT** or **Select** to choose **Directory**.
3. Press **MENU/SELECT** or **Select** to choose **Review**. The screen displays the first entry in the directory.
4. Press **▲DIR** or **▼CID** to browse through the directory. Entries appear in alphabetical order.
5. Press and hold **OFF/CANCEL** to return to idle mode.

Directory

Search directory

Search by name

Follow the steps below to search for directory entries on the handset.

1. When the handset is idle, press **▲DIR**.
2. Use the dial pad keys (**2-9**) to start a name search.
 - If there is an entry matching the letter you press, the directory shows the first name beginning with that letter.
 - If there is no entry matching the letter you press, the directory shows the next closest entry or the last entry.
3. To see other names starting with the letters on the same dial pad key, keep pressing **▲DIR** or **▼CID**.

For example, if you have the names **Jennifer**, **Jessie**, **Kevin** and **Linda** in your directory:

- If you press **5 (JKL)** once, you see **Jennifer**.
- If you press **5 (JKL)** twice, you see **Kevin**.
- If you press **5 (JKL)** three times, you see **Linda**.
- To view **Jessie**, press **▼CID** while **Jennifer** is displayed.

Directory

Dial, delete or edit entries

You can dial, delete or edit a directory entry (name and number) when it is shown on the handset. You can use the directory review (page 50) or name search (page 51) to show an entry.

Display dial

When a number is displayed on the screen, you can dial the number by pressing the desired line key (**LINE 1-LINE 4**) or **🔊/SPEAKER**.

Delete an entry

When a directory entry appears, press **MUTE/DELETE**, the screen display **Delete contact?**. Press **Yes** to confirm. You hear a confirmation tone.

Edit an entry

1. When a directory entry appears, press **Edit**.
2. The screen displays **Edit number**. Use the dialing keys to edit the number.
 - Press **MUTE/DELETE** to delete a digit.
 - Press and hold **MUTE/DELETE** to delete all digits.
 - Press **▲DIR** or **▼CID** to move the cursor to the left or right.
3. Press **MENU/SELECT** or **Save** to proceed. The screen displays **Edit name**. Use the dialing keys to edit the name.
 - Press **MUTE/DELETE** to delete a character.
 - Press and hold **MUTE/DELETE** to delete all characters.
 - Press **▲DIR** or **▼CID** to move the cursor to the left or right.
4. Press **MENU/SELECT** or **Save** to save. The handset displays **Contact saved**. To exit without making changes, press **OFF/CANCEL**.

Call history

About the caller ID

This telephone supports caller ID services that most telephone service providers offer. Caller ID allows you to see the name, number, date and time of calls. Depending on your service subscription, you might see the caller's number, or the caller's name and number from the telephone service provider after the first or second ring. Caller ID information might not be available for every incoming call. Callers may intentionally block their names and/or telephone numbers.

This product can provide information only if both you and the caller are in areas offering caller ID service and if both telephone service providers use compatible equipment.

Information about caller ID with call waiting

Caller ID with call waiting lets you see the name and telephone number of the caller before answering the telephone, and while on another call. The time and date, along with the call information, are from the telephone service provider.

It might be necessary to change telephone service to use this feature. Contact your telephone service provider if:

- You have both caller ID and call waiting, but as separate services (you might need to combine these services).
- You only have caller ID service, or only call waiting service.
- You do not subscribe to caller ID or call waiting services.

There are fees for caller ID services. In addition, services may not be available in all areas.



NOTE: You can use this product with regular caller ID service. You can also use this product's other features without subscribing to caller ID or combined caller ID with call waiting service.

Call history

Caller ID information

How the caller ID information (call log) works

The telephone stores caller ID information for the last 50 incoming calls in the handset. Entries are stored in reverse chronological order. The telephone deletes the oldest entry when the log is full to make room for new calls.

Each extension has independent caller ID information. Deleting the caller ID information on any one extension does not affect the caller ID information on other extensions.

If you answer a call before the information appears on the screen, it does not show in the caller ID information.

Review the caller ID information to determine who called, easily return the call, or copy the caller's name and number into your directory.

The time and date of the call and the caller's name and telephone number are included in the display.

Caller ID information appears on the screen as the telephone rings, or until the caller hangs up, or the call has been answered at another extension, or the call ends.

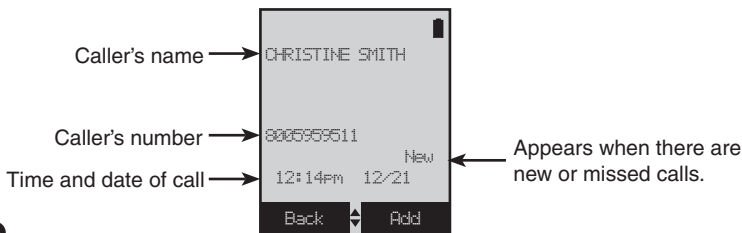

NOTES:

- The caller ID information might not be available for every incoming call. Callers might intentionally block their names and/or telephone numbers.
- Each entry can store up to 24 digits for the telephone number and 16 characters for the name.

Call history

Caller ID operation

Memory match

If the incoming telephone number is an exact match with a telephone number in your directory, the name that appears on the screen matches the corresponding name in your directory.

For example, if Christine Smith calls, her name appears as Chris if this is how you entered it into your directory.



NOTE: The number you see on your caller ID is in the format from the telephone service provider. It usually delivers 10-digit telephone numbers (area code plus telephone number). The telephone system ignores the area code when searching for a match and displays the name of the first corresponding number from the directory.

Missed (new) calls indicator

When there are new or missed calls and you try to review the caller ID log by pressing ▼CID, the screen shows **XX Missed call(s)**.

All new or missed entries are counted as missed calls. Each time you review a call history entry with the icon **new**, the missed calls message goes away.

Call history

Caller ID operation

Review the caller ID information

1. When the handset is idle, press **▼CID**. The handset displays **XX Missed Calls**.
2. Press **▲DIR** or **▼CID** to review the caller ID information. The caller ID history entries are stored in reverse chronological order, starting with the most recent entry.
3. To exit without making changes, press **OFF/CANCEL**.

-OR-

1. When the handset is idle, press **MENU/SELECT**.
2. Press **▲DIR** or **▼CID** to scroll to **Call history**, then press **MENU/SELECT** or **Select**. The handset displays **XX Missed Calls**.
3. Press **▲DIR** or **▼CID** to review the caller ID information. The caller ID history entries are stored in reverse chronological order, starting with the most recent entry.
4. To exit without making changes, press **OFF/CANCEL** twice.

View dialing options

Although the incoming call history entries have 10 digits (the area code plus the seven-digit number), in some areas, you may need to dial the seven digits only, 1 plus the seven digits, or 1 plus the area code plus the seven digits. You can change and store the number of digits that you dial in the call history.

While reviewing the call history, press **#** (pound key) repeatedly on the console to show different dialing options for local and long distance numbers before dialing or saving the telephone number in the directory.

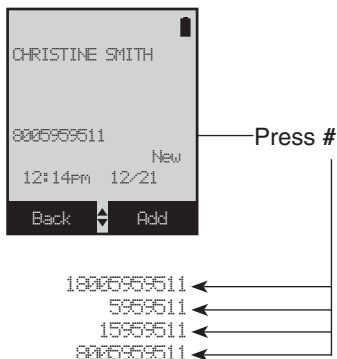

Call history

Caller ID operation

Dial a call history entry

1. When in the caller ID history, press ▲DIR or ▼CID to browse the number you wish to call.
2. Press the desired line key (**LINE 1-LINE 4**) or 📞/SPEAKER.

Save a caller ID entry to the directory

1. When in the caller ID history, press ▲DIR or ▼CID to browse the desired number to save.
2. Press **Add**. The screen displays **Edit number**. Use the dialing keys to edit the number.
 - Press **MUTE/DELETE** to delete a digit.
 - Press and hold **MUTE/DELETE** to delete all digits.
 - Press ▲DIR or ▼CID to move the cursor to the left or right.
3. Press **MENU/SELECT** or **Save** to proceed. The screen displays **Edit name**. Use the dialing keys to edit the name.
 - Press **MUTE/DELETE** to delete a character.
 - Press and hold **MUTE/DELETE** to delete all characters.
 - Press ▲DIR or ▼CID to move the cursor to the left or right.
 - Press **0** to add a space.
4. Press **MENU/SELECT** or **Save** to save. To exit without making changes, press **OFF/CANCEL**.



NOTE: You will need to change how a caller ID number is dialed if the entry does not appear in the correct format. Caller ID numbers may appear with an area code that might not be necessary for local calls, or without a 1 that might be necessary for long distance calls (see **View dialing options** on page 56 for more information).

Call history

Caller ID operation

Delete entries

To delete a call history entry:

1. When in the caller ID history, press ▲DIR or ▼CID to browse the desired number.
2. Press MUTE/DELETE.

To delete all call history entries:

1. When the handset is idle, press ▼CID. The handset displays **XX Missed Calls**.
2. Press MUTE/DELETE, the screen displays **Delete all calls?**.
3. Press **Yes** to confirm.

-OR-

1. When the handset is idle, press MENU/SELECT.
2. Press ▲DIR or ▼CID to scroll to **Call history**, then press MENU/SELECT or **Select**. The handset displays **XX Missed Calls**.
3. Press MUTE/DELETE, the screen displays **Delete all calls?**.
4. Press **Yes** to confirm.

Call history

Reasons for missing caller ID information

There are also occasions when other information or no information shows for various reasons:

On-screen message	Reason
PRIVATE NUMBER	The number has been set as private.
PRIVATE NAME	The name has been set as private.
PRIVATE CALLER	Both the name and number have been set as private.
UNKNOWN NUMBER	The number has been set as out of area.
UNKNOWN NAME	The name has been set as out of area.
UNKNOWN CALLER	Both the name and number have been set as out of area.

Answering system

Private mailbox setup

This handset has a private mailbox that can answer calls and record messages when the auto attendant of the console and the private mailbox of the handset are turned on.

When the auto attendant in the console picks up a call, the caller has to enter the extension number of this handset to access the private mailbox. The private mailbox answers the call after the ring delay time you set in the **Number of rings** section.

Activate private mailbox

There are three different mode of your private mailbox. You can turn it **On** or **Off**, or choose **Announce only**. If you choose **Announce only**, your handset plays an announcement only, and the call is then dropped automatically.

1. When the handset is idle, press **M.Box**.
2. Press **▲DIR** or **▼CID** to scroll to **Mailbox On/Off**, then press **MENU/SELECT** or **Select**.
3. Press **▲DIR** or **▼CID** to scroll to **On**, **Off** or **Announce only**.
4. Press **MENU/SELECT** or **Select** to save the setting.

Answering system

Private mailbox setup

Number of rings

You can set the number of times your handset rings before the private mailbox picks up a call.

1. When the handset is idle, press **M.Box**.
2. Press **▲DIR** or **▼CID** to scroll to **Settings**, then press **MENU/SELECT** or **Select**.
3. Press **▲DIR** or **▼CID** to scroll to **Mailbox On** or **Announce only**, then press **MENU/SELECT** or **Select**.
4. Press **MENU/SELECT** or **select** to choose **No. of rings**.
5. Press **▲DIR** or **▼CID** to choose the desired number of times (**2-7**) or **Toll saver**.
 - **Toll saver** - the private mailbox answers a call after two rings when there are new messages, and after four rings when there are no new messages. This enables you to check for new messages without paying for a toll call.
6. Press **MENU/SELECT** or **Select** to save the setting.

Voice language

The default language for mailbox's voice prompts is English. You can change to use French if desired. To change the setting and for more details, refer to the **Language** section in the user's manual of **CM18445** console.

Answering system

Private mailbox setup

Announcement

An announcement plays when calls are answered by the private mailbox. The system has a default announcement, “*Extension X is not available to answer your call right now. Please leave a message after the tone.*” (X is the extension number of your handset.) You can use this announcement or record your own.

You can record an announcement up to 90 seconds.

To record the announcement:

1. When the handset is idle, press **M.Box**.
2. Press **▲DIR** or **▼CID** to scroll to **Settings**, then press **MENU/SELECT** or **Select**.
3. Press **▲DIR** or **▼CID** to scroll to **Mailbox On** or **Announce only**, then press **MENU/SELECT** or **Select**.
4. Press **▲DIR** or **▼CID** to scroll to **Annment setup**, then press **MENU/SELECT** or **Select**.
5. Press **▲DIR** or **▼CID** to scroll to **User annment**, then press **MENU/SELECT** or **Select**.
 - If you have recorded your own announcement before, press **▲DIR** or **▼CID** to scroll to **Change**.
6. Press **MENU/SELECT** or **Record** to start recording. Speak towards the microphone to record your announcement.
7. Press **MENU/SELECT** or **Stop** to stop recording. You hear the playback of the recording.
8. Press **▲DIR** or **▼CID** to choose **OK** to save the recording, or choose **Change** to record again if desired. Press **MENU/SELECT** or **Select**.

Answering system

Private mailbox setup

To play the recorded announcement:

1. When the handset is idle, press **M.Box**.
2. Press **▲DIR** or **▼CID** to scroll to **Settings**, then press **MENU/SELECT** or **Select**.
3. Press **▲DIR** or **▼CID** to scroll to **Mailbox On** or **Announce only**, then press **MENU/SELECT** or **Select**.
4. Press **▲DIR** or **▼CID** to scroll to **Annment setup**, then press **MENU/SELECT** or **Select**.
5. Press **▲DIR** or **▼CID** to scroll to **User annment**, then press **MENU/SELECT** or **Select**. The current announcement plays.

To play and select the default announcement:

1. When the handset is idle, press **M.Box**.
2. Press **▲DIR** or **▼CID** to scroll to **Settings**, then press **MENU/SELECT** or **Select**.
3. Press **▲DIR** or **▼CID** to scroll to **Mailbox On** or **Announce only**, then press **MENU/SELECT** or **Select**.
4. Press **▲DIR** or **▼CID** to scroll to **Annment setup**, then press **MENU/SELECT** or **Select**.
5. Press **MENU/SELECT** or **Select** to choose **Default**. The default announcement plays.
6. Press **MENU/SELECT** or **OK** to save the setting.

Answering system

Private mailbox setup

Remote access code

Use this code to select a three-digit number to allow remote access of the answering system from another telephone. You can change the code to any number from **000-999**. This code is **000** by default.

1. When the handset is idle, press **M.Box**.
2. Press **▲DIR** or **▼CID** to scroll to **Settings**, then press **MENU/SELECT** or **Select**.
3. Press **MENU/SELECT** or **Select** to choose **Remote access**.
4. Use the dialing keys to enter a three-digit remote code.
 - Press **MUTE/DELETE** to delete a digit.
 - Press **▲DIR** or **▼CID** to move the cursor to the left or right.
5. Press **MENU/SELECT** or **Save** to save the setting and return to the previous menu.

Message Length

Use this feature to set the maximum length of each recorded message. The caller can record a message up to that specific time period.

1. When the handset is idle, press **M.Box**.
2. Press **▲DIR** or **▼CID** to scroll to **Settings**, then press **MENU/SELECT** or **Select**.
3. Press **▲DIR** or **▼CID** to scroll to **Message length**, then press **MENU/SELECT** or **Select**.
4. Press **▲DIR** or **▼CID** to scroll to **1 minute**, **2 minutes** or **3 minutes**.
5. Press **MENU/SELECT** or **Select** to save the setting and return to the previous menu.

Answering system

Private mailbox setup

Call screening

Use this feature to choose whether incoming messages can be heard over the speaker when they are being recorded. This feature is set to **On** by default. You hear the incoming message on your handset when a call comes in.

1. When the handset is idle, press **M.Box**.
2. Press **▲DIR** or **▼CID** to scroll to **Settings**, then press **MENU/SELECT** or **Select**.
3. Press **▲DIR** or **▼CID** to scroll to **Call screening**, then press **MENU/SELECT** or **Select**.
4. Press **▲DIR** or **▼CID** to scroll to **On** or **Off**.
5. Press **MENU/SELECT** or **Select** to save the setting and return to the previous menu.

Call intercept

When a caller is leaving a message on your private mailbox, you can stop the recording and talk to the caller by pressing the corresponding line key (**LINE 1-LINE 4**). Choose whether private incoming messages can be intercepted by the handset during recording.

1. When the handset is idle, press **M.Box**.
2. Press **▲DIR** or **▼CID** to scroll to **Settings**, then press **MENU/SELECT** or **Select**.
3. Press **▲DIR** or **▼CID** to scroll to **Call intercept**, then press **MENU/SELECT** or **Select**.
4. Press **▲DIR** or **▼CID** to scroll to **On** or **Off**.
5. Press **MENU/SELECT** or **Select** to save the setting and return to the previous menu.

Answering system

Private mailbox setup

Message alert

Use this feature to turn the audible message alert on or off.

If the message alert tone is on, the handset beeps every 10 seconds when there are new messages in the private mailbox.

1. When the handset is idle, press **M.Box**.
2. Press **▲DIR** or **▼CID** to scroll to **Settings**, then press **MENU/SELECT** or **Select**.
3. Press **▲DIR** or **▼CID** to scroll to **Msg alert tone**, then press **MENU/SELECT** or **Select**.
4. Press **▲DIR** or **▼CID** to scroll to **On** or **Off**.
5. Press **MENU/SELECT** or **Select** to save the setting and return to the previous menu.



NOTE: You can press any keys to temporarily silence the message alert tone when it is playing. The message alert tone resumes when a new message is recorded.

Remaining time

The maximum recording time of the handset is 15 minutes. You can record up to 99 messages in the handset. Use this feature to check the remaining recording time and message capacity in the system.

1. When the handset is idle, press **M.Box**.
2. Press **▲DIR** or **▼CID** to scroll to **Remaining time**, then press **MENU/SELECT** or **Select**. The remaining time and message capacity display.
3. Press **OFF/CANCEL** or **OK** to return to the previous menu.

Answering system

Answering system operation

New message indication

The handset displays **XX New messages** when there are new messages and/or memos in the private mailbox.

Call screening

When the answering system and call screening are turned on (see **Call screening** on page 65), and a message is being recorded, press **Screen** to hear the incoming message.

During message recording, press **-/VOLUME/+** to adjust the volume.

Press **Stop** to stop the call screening.

Call intercept

When a caller is leaving a message on your private mailbox, you can stop the recording and talk to the caller by pressing the corresponding line key (**LINE 1-LINE 4**). You can turn this feature on or off. See **Call intercept** on page 65.

Answering system

Answering system operation

Message playback

From the handset, you can play the messages in the private mailbox and the general mailbox. You can choose to play the new messages only or play old messages.

When playback begins, the total number of messages is announced. Before each message, you hear the date and time of the recording. After the last message, you hear, “*End of the messages.*”



NOTE: Messages in general mailbox are stored in console.

To listen to messages in the private mailbox:

1. When the handset is idle, press **M.Box**.
2. Press **MENU/SELECT** or **Select** to select **Play messages**.
3. If you have only new messages or only old messages, the handset plays the messages directly.

-OR-

If you have both new and old messages, press **▲DIR** or **▼CID** to choose **New messages** to play the new messages only, or **Old messages** to play old messages in the private mailbox. Press **MENU/SELECT** or **Select** to play the messages.

To listen to messages in the general mailbox:

1. When the handset is idle, press **M.Box**.
2. Press **▲DIR** or **▼CID** to scroll to **Gen MB**, then press **MENU/SELECT** or **Select**.
3. Press **MENU/SELECT** or **Select** to choose **Play messages**.
4. If you have only new messages or only old messages, the handset plays the messages directly.

-OR-

If you have both new and old messages, press **▲DIR** or **▼CID** to choose **New messages** to play the new messages only, or **Old messages** to play old messages in the general mailbox. Press **MENU/SELECT** or **Select** to play the messages.

Answering system

Answering system operation

Options during playback

When a message is playing, you can adjust the playback volume, skip, repeat, delete the message, or switch between speakerphone and handset earpiece.

- Press **-/VOLUME/+** to adjust the message playback volume.
- Press **Skip** after the date and time announcement to skip to the next message.
- Press **Repeat** to repeat the current message. Immediately press **Repeat** after the date and time announcement to hear the previous message.
- Press **MUTE/DELETE** after the date and time announcement to delete the message. The system announces *"Message deleted."*
- Press **🔊/SPEAKER** to switch between the speakerphone and handset earpiece.

Transfer messages

When a message in the handset mailbox is playing, you can transfer the message to a desired extension.

1. Press **MENU/SELECT** while the handset is playing a message.

Press **▲DIR** or **▼CID** to scroll to a desired extension, then press **MENU/SELECT** or **Select**.

If you transfer the message to the console, the handset displays **Message transferred to extension 0** and announces, *"Message transferred to general mailbox."*

If you transfer the message to other extension, the handset displays **Message transferred to extension X** and announces, *"Message transferred to extension mailbox X."*

Answering system

Answering system operation

Delete all mailbox messages

You can use delete all messages stored in the private mailbox or stored in the general mailbox.

To delete all messages in the private mailbox:

1. When the handset is idle, press **M.Box**.
2. Press **▲DIR** or **▼CID** to scroll to **Delete all old**, then press **MENU/SELECT** or **Select**.
3. The screen displays **Delete all old messages?** Press **MENU/SELECT** or **Yes** to confirm. The screen displays **All old msgs deleted**.

To delete all messages in the general mailbox:

1. When the handset is idle, press **M.Box**.
2. Press **▲DIR** or **▼CID** to scroll to **Gen MB**, then press **MENU/SELECT** or **Select**.
3. Press **▲DIR** or **▼CID** to scroll to **Delete all old**, then press **MENU/SELECT** or **Select**.
4. The screen displays **Delete all old messages?** Press **MENU/SELECT** or **Yes** to confirm. The screen displays **All old msgs deleted**.

Answering system

Answering system operation

Record memo

Memos are messages you record into the handset mailbox. You can save, play back, and delete them like incoming messages. You can record a memo as a reminder to yourself, or send a message to other extensions using the answering system.

1. When the handset is idle, press **M.Box**.
2. Press **▲DIR** or **▼CID** to scroll to **Record Memo**, then press **MENU/SELECT** or **Select**.
3. Press **▲DIR** or **▼CID** to scroll to a desired extension, then press **MENU/SELECT** or **Select**.
4. Press **Record** to start recording.
5. Press **Stop** to stop recording. You hear the playback of the recording.
6. Press **OK** to save the recording, or press **Change** to record again if desired.

Answering system

Remote access

Use this feature to reach your answering system remotely by calling any telephone line connected this handset from any touch-tone telephone. Make sure the auto attendant feature of your CM18445 console, and the private mailbox of the extension are turned on for this feature to work. Remote access can only play messages stored in the private mailbox.

To remotely reach the answering system:

1. Dial any telephone line connected to the console from any touch-tone telephone.
2. When the system answers, enter the extension number.
3. Once the private mailbox of the extension answers, enter the three-digit remote access code (**000** is the default code; see **Remote access code** on page 64 to change it).
4. Enter the following remote commands.

Remote commands:

1	Press to play all messages.
2	Press to delete all old messages.
3	Press to delete the current message (during playback).
4	Press to repeat the current message (during playback). Within 5 seconds of message playback, press 4 again to listen to the previous message (during playback).
5	Press to stop and return to the remote commands (during playback).
6	Press to skip to the next message (during playback).
8	Press to transfer the current message (during playback).
#	Press to end the call.

Answering system

Remote access

5. Hang up to end the call.



NOTES:

- If you do not enter the valid remote access code after you enter the answering system successfully, the answering system starts to record the message after the tone.
- When there is no new message or all the new messages are played during remote access, you hear a help menu listing all features and commands. If there is no command after the help menu is played three times, the call ends automatically.

Appendix

Deregister a handset

You may need to deregister the handset from the console if you already have nine registered devices and need to replace a handset, or if you wish to change the assigned number of your registered devices.

You must first deregister the desired device(s), and then register the device(s) individually.

Please make sure the telephone system is not in use before deregistration.

To deregister a handset from the CM18445 console:

1. On the console, press **MENU/SELECT**.
2. Press **▲** or **▼** to scroll to **Registration**, then press **MENU/SELECT** or **▶/SKIP**.
3. Press **▲** or **▼** to scroll to **Deregistration**, then press **MENU/SELECT** or **▶/SKIP**.
4. Press **▲** or **▼** to scroll to a desired extension, then press **MENU/SELECT** or **▶/SKIP**.
5. Deregistration will remove all existing voicemail messages saved in the selected extension. Press **▲** or **▼** to scroll to **Yes**, then press **MENU/SELECT** or **▶/SKIP**.
 - If there is no voicemail message in the extension, press **▲** or **▼** to choose **Yes** to continue the deregistration.
6. Deregistration starts after the existing voicemail messages are deleted. When the deregistration is successful, there is a confirmation tone and the console shows the completion message.



NOTE: To register the cordless handset to your console again, refer to the registration information on page 8.

Appendix

Handset display screen messages

All calls deleted.	All Caller ID histories are deleted.
All group settings clear.	All group settings for paging call are cleared.
All old msgs deleted.	All old messages in the private mailbox are deleted.
Call history empty	There are no entries in the caller ID history.
Calling:	The handset is making an intercom call.
Conf.	The handset is in a conference call.
Contact saved	A number is saved to the directory.
Deleted	A Caller ID history is deleted.
Directory empty	There are no directory entries.
Directory full	The directory is full. You cannot save new entries unless you delete some current entries.
Do Not Disturb	The do not disturb feature is on.
Ended	You have just ended a call.
Extension busy	The destination extension is on an intercom call.
Intercom	The handset is on an intercom call.
—Intercom—	There is an intercom call coming in.
Intercom in use	The handset is holding an intercom call and cannot barge-in a line.

Appendix

Handset display screen messages

Line in conf.	You cannot barge-in a conference call.
Line user's intercom in use	The extension on the desired line is holding an intercom. You cannot barge-in it at the moment.
Line X	The telephone line X is in use.
—Line X— Incoming call	There is an incoming call from line X.
Line X transferred to	The handset is transferring a call to a system extension.
Memory full	The private mailbox of the designated extension is full.
Message transferred to extension X	A message is transferred from private mailbox of handset to mailbox of extension X.
No battery	The battery is not properly installed and the handset is in the charger.
Number already saved	The telephone number you have entered is already stored in the directory.
Paging...	A paging call is established to other system extensions.
Private call	Call privacy is turned on on the line your are trying to reach.
Redial empty	The redial list is empty.
Reset deskset...	The handset telephone settings are reset to default settings.

Appendix

Handset display screen messages

System busy. Try again later	The private mailbox is in use or an extension is holding a call. You cannot reset the handset settings to default.
XX Missed calls	There are new calls in the caller ID history.
XX New messages	There are new messages in the private mailbox.

Appendix

Troubleshooting

If you have difficulty with your telephone, please try the suggestions below. For customer service, visit our website at www.vtechphones.com or call **1 (800) 595-9511**. In Canada, dial **1 (800) 267-7377**

The handset registration is unsuccessful.

- Follow the handset registration instructions to register the handset again (see **Add and register a handset** on page 8).

My telephone doesn't work at all.

- Make sure the power cord is securely plugged in.
- Make sure you plug the battery connector securely into the cordless handset.
- Make sure you plug the telephone line cords securely and firmly into the console and the telephone wall jacks.
- Charge the battery in the cordless handset for at least 11 hours. For optimum daily performance, return the cordless handset to the charger when not in use.
- If the battery is depleted, charge the handset for at least 30 minutes before you use it. See page 4 for details.
- You may need to purchase a new battery. Refer to **Battery installation and charging** on pages 4-5.

Appendix

Troubleshooting

There is no dial tone.

- Try all the suggestions above.
- Move the cordless handset closer to the console. You may have moved out of range.
- If the previous suggestions do not work, disconnect the telephone line from the console and connect it to a different phone. If there is no dial tone on that phone either, the problem is in your wiring or telephone service. Contact your telephone service provider.
- Your line cord may be defective. Try installing a new line cord.

I cannot dial out.

- Try all the suggestions above.
- Make sure you have a dial tone before dialing. The cordless handset may take a second or two to find the console and produce a dial tone. This is normal. Wait an extra second before dialing.
- Eliminate any background noise. Noise from a television, radio or other appliances may cause the phone to not dial out properly. If you cannot eliminate the background noise, try muting the cordless handset before dialing, or dialing from another room with less background noise.
- If other phones in your home are having the same problem, contact your telephone service provider (charges may apply).

Appendix

Troubleshooting

My cordless handset isn't performing normally.

- Move the cordless handset closer to the console. You may have moved out of range.
- Reset the console. Unplug the electrical power. Wait for 15 seconds, then plug it back in. Allow at least one minute for the console to reset.
- Other electronic products such as HAM radios and other DECT phones can cause interference with your cordless phone. Try installing your phone as far away as possible from these types of electronic devices.

Out of range OR No power at base appears on my cordless handset.

- Ensure you plug the power into the console properly.
- Move the cordless handset closer to the console. You may have moved out of range.
- Reset the console. Unplug the electrical power. Wait for 15 seconds, then plug it back in. Allow at least one minute for the cordless handset and console to reset.
- Other electronic products such as HAM radios and other DECT phones can cause interference with your cordless phone. Try installing your phone as far away as possible from these types of electronic devices.

Appendix

Troubleshooting

The batteries do not hold a charge.

- If the cordless handset is in the charger and the charge light is not on, refer to **The charge light is off** (page 85).
- Charge the battery in the cordless handset for at least 11 hours. For optimum daily performance, return the cordless handset to the charger when not in use.
- If the battery is depleted, it may take approximately 30 minutes to charge the handset before it shows **Low battery**. Refer to the table on page 4 for details.
- You may need to purchase a new battery. Refer to **Battery installation and charging** on pages 4-5.

I get noise, static, or weak signals on my cordless handset even when I'm near the console.

- If you subscribe to high-speed Internet service (DSL - digital subscriber line) through your telephone lines, you must install a DSL filter between each telephone line cord and telephone wall jack. The filter prevents noise and caller ID problems as a result of DSL interference. Please contact your DSL service provider for more information about DSL filters.
- You may be able to improve the performance by installing your console as far as possible from any other existing corded or cordless telephone system that may already be installed.
- Other electronic products such as HAM radios and other DECT phones can cause interference with your cordless phone. Try installing your phone as far away as possible from these types of electronic devices.
- Do not install this handset near a microwave oven or on the same electrical outlet. You might experience decreased performance while the microwave oven is operating.

Appendix

Troubleshooting

- If you plug your telephone in with a modem or a surge protector, plug the phone (or modem/surge protector) into a different location. If this does not solve the problem, relocate your console or modem farther apart from one another, or use a different surge protector.
- Relocate your telephone to a higher location. The telephone might have better reception in a high area.
- If the other telephones in your building are having the same problem, contact your telephone service provider.

I experience poor sound quality when using the speakerphone.

- For increased sound quality while using the speakerphone, place the handset on a flat surface with the dialing keys facing up.
- When using a speakerphone, controlling background noise in your environment is essential. While you are listening to your party, press **MUTE/DELETE** to temporarily turn your microphone off. When it is your turn to speak, remember to press **MUTE/DELETE** again to turn the microphone on.
- Excessive background noise will cause a speakerphone to fade in and out. Try controlling the background noise by turning off any audio devices near the speakerphone. Also, try to avoid interrupting the person at the other end of the conversation while they are speaking. If background noise cannot be controlled, you should terminate speakerphone operation and return to normal handset mode.

Appendix

Troubleshooting

My cordless handset does not ring when I receive a call.

- Make sure that the ringer is not off (page 20).
- Make sure you plug the telephone line cords securely and firmly into the console and the telephone wall jacks.
- The cordless handset may be too far from the console.
- Charge the battery in the cordless handset for at least 11 hours. For optimum daily performance, return the cordless handset to the charger when not in use.
- The layout of your home or office may be limiting the operating range. Try moving the console to another location, preferably on an upper floor.
- If other phones in your home are having the same problem, contact your telephone service provider (charges may apply).
- Test a working phone at the phone jack. If another phone has the same problem, contact your telephone service provider (charges may apply).
- Other electronic products such as HAM radios and other DECT phones can cause interference with your cordless phone. Try installing your phone as far away as possible from these types of electronic devices.
- Remove the battery. Replace it and place the cordless handset into the charger. Allow up to one minute for the handset to reestablish its connection with the console.

Appendix

Troubleshooting

My calls cut in and out while I'm using my cordless handset.

- Other electronic products such as HAM radios and other DECT phones can cause interference to your cordless telephone. Try installing your telephone as far away as possible from these types of electronic devices.
- Do not install this phone near a microwave oven or on the same electrical outlet. You may experience decreased performance while the microwave oven is operating.
- If you plug your phone in with a modem or surge protector, plug the phone (or modem/surge protector) into a different location. If this doesn't solve the problem, relocate your phone or modem farther apart from one another, or use a different surge protector.
- Relocate your console to a higher location. The phone may have better reception when installed in a high area.
- Disconnect the console from the telephone wall jack and plug in a working telephone. If the other phones in your home are having the same problem, the problem is in your wiring or telephone service. Contact your telephone service provider (charges may apply).
- Excessive background noise will cause a speakerphone to fade in and out. Try controlling the background noise by turning off any audio devices near the speakerphone. Also, try to avoid interrupting the person at the other end of the conversation while they are speaking. If background noise cannot be controlled, you should stop speakerphone operation and return to normal handset mode.
- When using a speakerphone, controlling background noise in your environment is essential. While you are listening to your party, press **MUTE/DELETE** to temporarily turn your microphone off. When it is your turn to speak, remember to press **MUTE/DELETE** to turn the microphone on.

Appendix

Troubleshooting

My caller ID isn't working.

- Caller ID is a subscription service. You must subscribe to this service from your telephone service provider for this feature to work on your cordless handset.
- The caller must be calling from an area that supports caller ID.
- Both your and your caller's telephone service providers must use caller ID compatible equipment.
- If you subscribe to high-speed Internet service (DSL - digital subscriber line) through your telephone lines, you must install a DSL filter between each telephone line cord and telephone wall jack. The filter prevents noise and caller ID problems resulting from DSL interference. Please contact your DSL service provider for more information about DSL filters.

System does not receive caller ID when on a call.

- Make sure you subscribe to caller ID with call waiting features from your telephone service provider. Caller ID features work only if both you and the caller are in areas offering caller ID service, and if both telephone service providers use compatible equipment.

The charge light is off.

- Make sure you plug the power adapter into an electrical outlet correctly and securely.
- Unplug the electrical power. Wait for 15 seconds, then plug it back in. Allow up to one minute for the cordless handset to reset.
- Clean the cordless handset and charger charging contacts each month with a pencil eraser or cloth.

Appendix

Troubleshooting

Common cure for electronic equipment.

- If the telephone does not seem to be responding normally, try putting the cordless handset in the charger. If it does not fix the problem, do the following (in the order listed):
 1. Disconnect the power from the console.
 2. Remove the cordless handset battery.
 3. Wait a few minutes.
 4. Connect the power to the console.
 5. Replace the battery and place the cordless handset into the charger.
 6. Wait for the cordless handset to reestablish its connection with the console. This will take at least one minute to finish.

Appendix

Maintenance

Taking care of your telephone

- Your cordless telephone contains sophisticated electronic parts, so you must treat it with care.
- Avoid rough treatment.
- Place the corded handset down gently.
- Save the original packing materials to protect your cordless telephone if you ever need to ship it.

Avoid water

- You can damage your cordless telephone if it gets wet. Do not use the corded handset in the rain, or handle it with wet hands. Do not install the cordless telephone near a sink, bathtub or shower.

Electrical storms

- Electrical storms can sometimes cause power surges harmful to electronic equipment. For your own safety, take caution when using electric appliances during storms.

Cleaning your telephone

- Your cordless telephone has a durable plastic casing that should retain its luster for many years. Clean it only with a soft cloth slightly dampened with water or a mild soap.
- Do not use excess water or cleaning solvents of any kind.

Remember that electrical appliances can cause serious injury if used when you are wet or standing in water. If the charger should fall into water, DO NOT RETRIEVE IT UNTIL YOU UNPLUG THE POWER CORD FROM THE WALL, then pull the unit out by the unplugged cords.

Appendix

FCC Part 68 and ACTA

This equipment complies with Part 68 of the FCC rules and with technical requirements adopted by the Administrative Council for Terminal Attachments (ACTA). The label on the back or bottom of this equipment contains, among other things, a product identifier in the format US:AAAEQ##TXXXX. This identifier must be provided to your telephone service provider upon request.

The plug and jack used to connect this equipment to premises wiring and the telephone network must comply with the applicable Part 68 rules and technical requirements adopted by ACTA. A compliant telephone cord and modular plug is provided with this product. It is designed to be connected to a compatible modular jack that is also compliant. An RJ11 jack should normally be used for connecting to a single line and an RJ14 jack for two lines. See Installation Instructions in the user's manual.

The Ringer Equivalence Number (REN) is used to determine how many devices you may connect to your telephone line and still have them ring when you are called. The REN for this product is encoded as the 6th and 7th characters following the US: in the product identifier (e.g., if ## is 03, the REN is 0.3). In most, but not all areas, the sum of all RENs should be five (5.0) or less. For more information, please contact your telephone service provider.

This equipment may not be used with Party Lines. If you have specially wired alarm dialing equipment connected to telephone line, ensure the connection of this equipment does not disable your alarm equipment. If you have questions about what will disable the alarm equipment, consult your telephone service provider or a qualified installer.

If this equipment is malfunctioning, it must be unplugged from the modular jack until the problem has been corrected. Repairs to this telephone equipment can only be made by the manufacturer or its authorized agents. For repair procedures, follow the instructions outlined under the Limited Warranty.

If this equipment is causing harm to the telephone network, the telephone service provider may temporarily discontinue your telephone service. The telephone service provider is required to notify you before interrupting service. If advance notice is not practical, you will be notified as soon as possible. You will be given the opportunity to correct the problem and the telephone service provider is required to inform you of your right to file a complaint with the FCC. Your telephone service provider may make changes in its facilities, equipment, operation, or procedures that could affect the proper functioning of this product. The telephone service provider is required to notify you if such changes are planned.

Appendix

FCC Part 68 and ACTA

If this product is equipped with a corded or cordless handset, it is hearing aid compatible.

If this product has memory dialing locations, you may choose to store emergency telephone numbers (e.g., police, fire, medical) in these locations. If you do store or test emergency numbers, please:

Remain on the line and briefly explain the reason for the call before hanging up.

Perform such activities in off-peak hours, such as early morning or late evening.

Industry Canada

This device complies with Industry Canada licence-exempt RSS standard(s).

Operation is subject to the following two conditions: (1) this device may not cause harmful interference, and (2) this device must accept any interference received, including interference that may cause undesired operation.

Privacy of communication may not be ensured when using this telephone.

The term "IC:" before the certification/registration number only signifies that the Industry Canada technical specifications were met.

The Ringer Equivalence Number (REN) for this terminal equipment is 0.1. The REN is an indication of the maximum number of devices allowed to be connected to a telephone interface. The termination on an interface may consist of any combination of devices subject only to the requirement that the sum of the RENs of all the devices does not exceed five.

This product meets the applicable Industry Canada technical specifications.

This Class B digital apparatus complies with Canadian requirement:
CAN ICES-3 (B)/NMB-3(B).

Appendix

FCC Part 15

This equipment has been tested and found to comply with the requirements for a Class B digital device under Part 15 of the Federal Communications Commission (FCC) rules. These requirements are intended to provide reasonable protection against harmful interference in a residential installation. This equipment generates, uses and can radiate radio frequency energy and, if not installed and used in accordance with the instructions, may cause harmful interference to radio communications. However, there is no guarantee that interference will not occur in a particular installation. If this equipment does cause harmful interference to radio or television reception, which can be determined by turning the equipment off and on, the user is encouraged to try to correct the interference by one or more of the following measures:

- Reorient or relocate the receiving antenna.
- Increase the separation between the equipment and receiver.
- Connect the equipment into an outlet on a circuit different from that to which the receiver is connected.
- Consult the dealer or an experienced radio/TV technician for help.

Changes or modifications to this equipment not expressly approved by the party responsible for compliance could void the user's authority to operate the equipment.

This device complies with Part 15 of the FCC Rules. Operation is subject to the following two conditions: (1) this device may not cause harmful interference, and (2) this device must accept any interference received, including interference that may cause undesired operation. Privacy of communications may not be ensured when using this telephone.

To ensure safety of users, the FCC has established criteria for the amount of radio frequency energy that can be safely absorbed by a user or bystander according to the intended usage of the product. This product has been tested and found to comply with the FCC criteria. The handset may be safely held against the ear of the user. The console shall be installed and used such that parts of the user's body other than the hands are maintained at a distance of approximately 20 cm (8 inches) or more. If you choose to use a clipping device, please make sure to only use the supplied VTech belt clip.

For body worn operation, this handset has been tested and meets the FCC RF exposure guidelines when used with the belt clip supplied or designated for this product. Use of other accessories may not ensure compliance with FCC RF exposure guidelines.

Appendix

California Energy Commission battery charging testing instructions

This cordless handset is set up to comply with the energy-conserving standards right out of box. These instructions are intended for California Energy Commission (CEC) compliance testing only. When the CEC battery charging testing mode is activated, all telephone functions, except battery charging, will be disabled.

To activate the CEC battery charging testing mode:

1. On the CM18445 console, press **MENU/SELECT**.
2. Press ▲ or ▼ to scroll to **Registration**, then press **MENU/SELECT** or ►/SKIP.
3. Press ▲ or ▼ to scroll to **Deregistration**, then press **MENU/SELECT** or ►/SKIP.
4. Press ▲ or ▼ to choose this handset, then press **MENU/SELECT** or ►/SKIP.
5. Press ▲ or ▼ to scroll to **Yes**, then press **MENU/SELECT** or ►/SKIP. The console shows **Deregistering Handset X** (X represents the extension number).

The process takes up to 10 seconds to complete. When the handset successfully enters the CEC battery charging testing mode, its screen displays **1) Press MENU on Console ->Registration ->Register Ext. 2) Press # on this extension to register**. You hear a confirmation tone.

If the handset fails to enter this mode, repeat all the steps above.

To deactivate the CEC battery charging testing mode:

Register your handset back to the CM18445 console. See **Add and register a handset** on page 8 for the instructions.

Appendix

For C-UL compliance only

Mesures de sécurité importantes



Ce symbole vous alertera d'informations importantes ou d'instructions d'entretien pouvant apparaître dans ce guide d'utilisation. Respectez toujours les mesures de sécurité et de sécurité de base lorsque vous utilisez ce produit, afin de réduire les risques de blessures, d'incendie, ou d'électrocution.

Information relative à la sécurité

- Veuillez lire et comprendre toutes les instructions de ce guide d'utilisation. Relectez toutes les inscriptions apparaissant sur le produit.
- Évitez d'utiliser le téléphone pendant un orage. Il pourrait y avoir un faible risque d'électrocution.
- N'utilisez pas un téléphone près d'une fuite de gaz. Dans certaines circonstances, une flammèche pourrait se produire lorsque l'adaptateur est branché à une prise de courant, ou lorsque le combiné est déposé sur son chargeur. Ceci est un événement fréquent associé avec la fermeture d'un circuit électrique. L'utilisateur ne devrait pas brancher un téléphone dans une prise de courant, et ne devrait pas déposer un combiné chargé dans le chargeur, si le téléphone se trouve dans un environnement comportant une concentration de gaz inflammables ou ignifuges, à moins de se trouver dans un endroit où la ventilation est adéquate. Une flammèche dans de tels environnements pourrait provoquer une explosion. De tels environnements peuvent comprendre : les endroits où de l'oxygène à des fins médicales est utilisé sans ventilation adéquate; des endroits où se trouvent des gaz industriels (dissolvants de nettoyage, des vapeurs de gazoline, etc.), une fuite de gaz naturel, etc.
- N'utilisez pas ce produit près de l'eau ou lorsque vous êtes mouillés. Par exemple, ne l'utilisez pas dans des sous-sols humides ou sous la douche, ou près d'une piscine, d'un bain, d'un évier de cuisine, ou d'une cuve de lavage. N'utilisez pas de liquides, ou de vaporisateurs aérosol de nettoyage. Si le produit entre en contact avec du liquide, débranchez immédiatement le fil téléphonique ou le cordon d'alimentation. Ne rebranchez pas le produit avant qu'il soit complètement sec.
- Évitez d'installer le système téléphonique dans les endroits soumis à une température extrême, à la lumière directe du soleil ou à proximité immédiate d'autres appareils électriques ou électroniques. Protégez votre téléphone contre les sources d'humidité, la poussière, les vapeurs et les liquides corrosifs.
- Installez cet appareil dans un endroit protégé où personne ne peut trébucher sur les cordons d'alimentation ou la ligne téléphonique. Protégez les câbles contre les dommages ou l'abrasion.
- Si le produit ne fonctionne pas correctement, consultez la section Dépannage (Troubleshooting) des pages 78-86 de ce guide d'utilisation. Si vous ne pouvez pas régler le problème, ou si le produit est endommagé, consultez la section Garantie limitée (Limited warranty) des pages 96-98. N'ouvrez pas ce produit, sauf tel qu'indiqué dans le guide d'utilisation. L'ouverture du produit ou le remontage inadéquat pourrait vous exposer à des tensions dangereuses ou autres dangers.

Appendix

For C-UL compliance only

- Remplacez les piles uniquement tel que décrit dans votre guide d'utilisation. N'incinerez pas et ne percez pas les piles — elles contiennent des produits chimiques caustiques.
- Les adaptateurs secteurs sont conçus pour être orientés verticalement ou installés sur le plancher. Les broches ne sont pas conçues pour se maintenir en place si la fiche est branchée dans une prise de courant au plafond, sous la table ou sous une armoire.
- Pour les PRODUITS À BRANCHER À UNE PRISE DE COURANT, la prise de courant doit être installée près du produit, afin d'assurer une accessibilité sécuritaire à la prise de courant.



Mise en garde :

- N'utilisez que les adaptateurs inclus avec ce produit. Pour obtenir une pièce de rechange, visitez notre site Web au www.vtechphones.com ou composez le **1-800-595-9511**. Au Canada, composez le **1-800-267-7377**.
- N'utilisez que la pile de rechargeable incluse ou une pile de rechange. Pour commander, visitez notre site Web www.vtechphones.com ou composez le **1-800-595-9511**. Au Canada, composez le **1-800-267-7377**.
- Afin de prévenir les risques d'incendie ou d'explosion de la pile, remplacez la pile avec une pile du même type. Jetez les piles épuisées en respectant les instructions.

Spécifiquement en rapport avec les téléphones sans fil

- Confidentialité : Les mêmes caractéristiques qui rendent les téléphones sans fil si pratiques créent également des restrictions. Les appels téléphoniques sont transmis entre le socle du téléphone et le combiné par le biais d'ondes radio, et il se peut que vos conversations téléphoniques soient interceptées par d'autres équipements de réception d'ondes radio au sein de la portée du téléphone sans fil. Pour cette raison, vous ne devez pas considérer les conversations sur un téléphone sans fil comme étant aussi confidentielles que celles d'un téléphone à cordon.
- Alimentation électrique : La base de ce téléphone sans fil doit être branchée à une prise de courant électrique fonctionnelle. La prise électrique ne doit pas être contrôlée par un interrupteur mural. Les appels ne peuvent pas être effectués à partir du combiné si la base n'est pas branchée, si elle est hors fonction ou si le courant électrique est coupé.
- Interférences potentielles aux téléviseurs : Certains téléphones sans fil fonctionnent sur des fréquences pouvant causer des interférences aux téléviseurs et magnétoscopes. Pour réduire ou prévenir de tels parasites, ne pas déposer la base du téléphone sans fil à proximité d'un téléviseur ou magnétoscope, ni directement sur celui-ci. Si votre téléviseur affiche des interférences, éloignez le téléphone sans fil de celui-ci afin de réduire les parasites.

Appendix

For C-UL compliance only

- Piles rechargeables : Vous devez recycler ou jeter les piles de manière écologique. Ne pas jeter dans les rebuts domestiques. Ne pas brûler ni percer les piles. Comme pour les autres piles du même type, si elles sont brûlées ou percées, des matières corrosives peuvent s'en échapper, ce qui risque de causer des brûlures ou autres blessures corporelles.
- Piles rechargeables à l'hydrure métallique de nickel : Jetez ces piles de manière sécuritaire. N'incinérerez pas et ne percez pas les piles. Comme pour les autres piles du même type, si elles sont brûlées ou percées, des matières corrosives peuvent s'en échapper, ce qui risque de causer des brûlures ou autres blessures corporelles.



Le sceau de l'organisme de recyclage RBRC^{MD} sur les piles à l'hydrure métallique de nickel signifie que le fabricant de cet appareil participe volontairement au programme industriel visant à reprendre et recycler ce type de piles lorsqu'elles ne servent plus, au sein du territoire des États-Unis et du Canada. Vous devez apporter ces piles chez un détaillant participant ou le centre de recyclage le plus près de chez vous. Ou vous pouvez composer le 1-800-8BATTERY^{MD} afin de connaître les endroits qui acceptent les piles à l'hydrure métallique de nickel mortes.

RBRC^{MD} et 1-800-8-BATTERY^{MD} sont des marques déposées de Rechargeable Battery Recycling Corporation.

Mesures préventives pour les utilisateurs de stimulateurs cardiaques implantés dans l'organisme

Stimulateurs cardiaques (ne s'applique qu'aux téléphones sans fil numériques) :

L'organisme 'Wireless Technology Research, LLC (WTR)', une firme de recherche indépendante, a mené une évaluation pluridisciplinaire des interférences entre les téléphones sans fil portatifs et les stimulateurs cardiaques implantés dans l'organisme. Appuyée par l'Administration des aliments et drogues (FDA) des États-unis, la firme WTR recommande aux médecins :

Avis aux détenteurs de stimulateurs cardiaques

- Ils doivent tenir le téléphone sans fil à une distance d'au moins six pouces du stimulateur cardiaque.
- Ils ne doivent PAS placer le téléphone sans fil directement sur le stimulateur cardiaque, tel que dans une poche de chemise, lorsque celui-ci est en fonction.
- Ils doivent utiliser le téléphone sans fil en l'appuyant sur l'oreille qui se trouve dans la direction opposée au stimulateur cardiaque.

L'étude effectuée par l'organisme WRS n'a pas identifié de risque pour les détenteurs de simulateurs cardiaques causé par les gens qui utilisent un téléphone sans fil à proximité de ceux-ci.

Appendix

For C-UL compliance only

Spécifiquement en rapport avec les répondeurs téléphoniques

Enregistrement deux voies : Cet appareil n'émet pas de bips d'avertissement qui permettent de prévenir l'autre partie que vous enregistrez la conversation. Pour assurer votre conformité aux règlements fédéraux ou provinciaux en rapport avec les enregistrements des conversations téléphoniques, vous devriez informer l'autre partie lorsque vous activez l'enregistrement.

CONSERVEZ CES INSTRUCTIONS

Appendix

Limited warranty

1. What does this limited warranty cover?

The manufacturer of this VTech product warrants to the holder of a valid proof of purchase (“CONSUMER” or “you”) that the product and all accessories provided in the sales package (“PRODUCT”) are free from defects in material and workmanship, pursuant to the following terms and conditions, when installed and used normally and in accordance with the PRODUCT operating instructions. This limited warranty extends only to the CONSUMER for products purchased and used in the United States of America and Canada.

2. What will be done if the PRODUCT is not free from defects in materials and workmanship during the limited warranty period (“materially defective PRODUCT”)?

During the limited warranty period, VTech’s authorized service representative will repair or replace at VTech’s option, without charge, a materially defective PRODUCT. If we repair the PRODUCT, we may use new or refurbished replacement parts. If we choose to replace the PRODUCT, we may replace it with a new or refurbished PRODUCT of the same or similar design. We will retain defective parts, modules, or equipment. Repair or replacement of the PRODUCT, at VTech’s option, is your exclusive remedy. VTech will return repaired or replacement products to you in working condition. You should expect the repair or replacement to take approximately 30 days.

3. How long is the limited warranty period?

The limited warranty period for the PRODUCT extends for TWO (2) YEARS from the date of purchase. If VTech repairs or replaces a materially defective PRODUCT under the terms of this limited warranty, this limited warranty also applies to repaired or replacement PRODUCT for a period of either (a) 90 days from the date the repaired or replacement PRODUCT is shipped to you or (b) the time remaining on the original two-year limited warranty; whichever is longer.

Appendix

Limited warranty

4. What is not covered by this limited warranty?

This limited warranty does not cover:

- PRODUCT that has been subjected to misuse, accident, shipping or other physical damage, improper installation, abnormal operation or handling, neglect, inundation, fire, water, or other liquid intrusion; or
- PRODUCT that has been damaged due to repair, alteration, or modification by anyone other than an authorized service representative of VTech; or
- PRODUCT to the extent that the problem experienced is caused by signal conditions, network reliability or cable or antenna systems; or
- PRODUCT to the extent that the problem is caused by use with non-VTech accessories; or
- PRODUCT whose warranty/quality stickers, PRODUCT serial number plates or electronic serial numbers have been removed, altered or rendered illegible; or
- PRODUCT purchased, used, serviced, or shipped for repair from outside the United States of America or Canada, or used for commercial or institutional purposes (including but not limited to products used for rental purposes); or
- PRODUCT returned without a valid proof of purchase (see item 6 below); or
- Charges for installation or setup, adjustment of customer controls, and installation or repair of systems outside the unit.

5. How do you get warranty service?

To obtain warranty service, visit www.vtechphones.com or call **1 (800) 595-9511**. In Canada, please dial **1 (800) 267-7377**.

NOTE: Before calling for service, please review the user's manual; a check of the PRODUCT's controls and features may save you a service call.

Except as provided by applicable law, you assume the risk of loss or damage during transit and transportation and are responsible for delivery or handling charges incurred in the transport of the PRODUCT(s) to the service location. VTech will return repaired or replaced PRODUCT under this limited warranty to you. Transportation, delivery or handling charges are prepaid. VTech assumes no risk for damage or loss of the PRODUCT in transit. If the PRODUCT failure is not covered by this limited warranty, or proof of purchase does not meet the terms of this limited warranty, VTech will notify you and will request that you authorize the cost of repair prior to any further repair activity. You must pay for the cost of repair and return shipping costs for the repair of products that are not covered by this limited warranty.

Appendix

Limited warranty

6. What must you return with the PRODUCT to get warranty service?

You must:

- Return the entire original package and contents including the PRODUCT to the service location along with a description of the malfunction or difficulty; and
- Include a “valid proof of purchase” (sales receipt) identifying the PRODUCT purchased (PRODUCT model) and the date of purchase or receipt; and
- Provide your name, complete and correct mailing address, and telephone number.

7. Other limitations

This warranty is the complete and exclusive agreement between you and VTech. It supersedes all other written or oral communications related to this PRODUCT. VTech provides no other warranties for this PRODUCT. The warranty exclusively describes all of VTech’s responsibilities regarding the PRODUCT. There are no other express warranties. No one is authorized to make modifications to this limited warranty and you should not rely on any such modification.

State/Provincial Law rights: This warranty gives you specific legal rights, and you may also have other rights which vary from state to state or province to province.

Limitations: Implied warranties, including those of fitness for a particular purpose and merchantability (an unwritten warranty that the PRODUCT is fit for ordinary use) are limited to one year from date of purchase. Some states/provinces do not allow limitations on how long an implied warranty lasts, so the above limitation may not apply to you. In no event shall VTech be liable for any indirect, special, incidental, consequential, or similar damages (including, but not limited to lost profits or revenue, inability to use the PRODUCT or other associated equipment, the cost of substitute equipment, and claims by third parties) resulting from the use of this PRODUCT. Some states/provinces do not allow the exclusion or limitation of incidental or consequential damages, so the above limitation or exclusion may not apply to you.

Please retain your original sales receipt as proof of purchase.

Appendix

Technical specifications

RF frequency band	1921.536MHz - 1928.448MHz
Channels	5
Charger voltage (AC voltage, 50/60Hz)	100Vrms - 120Vrms
Charger voltage (Adapter output voltage)	6VDC @ 100mA
Battery pack	2.4V 400mAh Ni-MH battery
Headset jack	2.5mm, 32ohm - 150ohm

Operation	Operating time*
Talk time (cordless handset)	Up to 7.1 hours
Talk time (cordless handset speakerphone)	Up to 4.2 hours
Standby	Up to 4.5 days

* Operating times vary depending on your actual use and the age of the battery.

DECT 6.0 digital technology

Digital Enhanced Cordless Telecommunications (DECT) 6.0 is a new frequency band that transmits your voice across multiple channels. This technology provides superior quality of voice and sound, high protection against wiretapping and excellent range, while not interfering with wireless routers.

Telephone operating range

This cordless telephone operates within the maximum power allowed by the Federal Communications Commission (FCC). Even so, this handset and console can communicate over only a certain distance — which can vary with the locations of the console and handset, the weather, and the construction of your home or office.

Index

A

- Add a headset 10
- Add a speed dial entry 46–47
- Alert tones 18
- Announcement 62–63
- Answer a call 28
- Answer an intercom call 40

B

- Battery charging 4–5
- Battery installation 5
- Belt clip 9
- Blind transfer 42

C

- Call history 53–59
- Call intercept 65, 67
- Call privacy 24, 31
- Call screening 65, 67
- Call transfer 42
- Call waiting 29
- Caller ID 53–59
- Cardiac pacemakers iii, 94
- Chain dialing 33
- Conference call 36–39
- Contrast 22

D

- Default setting 26
- Delay 61
- Deregister a handset 74
- Dialing options 56
- Directory 48–52
- Directory capacity 48

- Display dial 52
- Do not disturb 21

E

- Edit directory 52
- End a call 27
- End an intercom call 40

F

- FCC, ACTA and IC regulations 88–90
- Flash 29

H

- Handsfree use 28
- Hold 30, 41
- Hold reminder 25

I

- Icons 17
- Important safety information i–iii
- Indication 18, 27, 67

K

- Key tone 22

L

- Language 23, 61
- Lights 18
- Limited warranty 96–98
- Line indicators 27
- Listening volume 29
- Lock keypad 28

M

- Mailbox setup 60–66
- Maintenance 87

Index

Make a call 27
Make an intercom call 40
Memo 71
Memory match 55
Menu settings 19
Message indication 67
Message playback 68–69
Missed (new) calls indicator 55
Mute 29

N

Name search 51
New message indication 67

O

On hook dialing (predialing) 27
Operating range 99
Operation 27–33
Overview 11–16

P

Pacemaker patients iii, 94
Paging 43–45
Phonebook (directory) 48–52
Predialing 27
Primary line 24
Privacy 24, 31
Private mailbox 60–66

R

Record a call 32
Redial 34–35
Register a handset 8
Remaining message capacity 66
Remaining time 66

Remote access 64, 72–73
Rename handset 25
Review call history 56
Review directory 50
Ringer tone 21
Ringer volume 20

S

Screen contrast 22
Search by name 51
Search for a contact 51
Set default 26
Settings 19–26
Speakerphone 28
Speed dial 46–47
Switch between lines 30
System setup 19–26

T

Technical specifications 99
Telephone operating range 99
Telephone operation 27–33
Temporary ringer silencing 28
Transfer a call 42
Troubleshooting 78–86
Two-way recording iii, 95

V

Volume 20, 29
Volume control 29

W

Wall mount 6–7
Warranty 96–98
Website 26

Source of music files for the Music on hold feature:
FreeMusicArchive.org. Used under open license.



Designed to fit your home.
And your life.

VTech Communications, Inc.

A member of THE VTECH GROUP OF COMPANIES.

VTech is a registered trademark of VTech Holdings Limited.

Specifications are subject to change without notice.

© 2015 VTech Communications, Inc.

All rights reserved. 04/15. CM18045_CIB_V2.0

Document order number: 91-008471-020-100